



InterFire
— AGENCIES —

WEBERRESCUE
SYSTEMS

LET'S CREATE FUTURE >

RESCUE TOOLS

**Hydraulic and Pneumatic
Rescue Systems
& Accessories**

LATEST RESCUE SOLUTIONS AND EQUIPMENT FROM WEBER RESCUE SYSTEMS

WEBER RESCUE SYSTEMS is an internationally leading, innovative manufacturer of high-quality equipment for technical rescue operations. The extensive range of our products are used in a number of areas. Mainly fire brigades but also national agencies, USAR teams, police and military forces are among our customers. We also provide our high-quality tools for various industrial applications, e.g. as in demolition and recycling plants.

New vehicle technologies and continual development of new safety features in the vehicle industry are improving the protection of drivers and passengers. Those improvements are constantly presenting new challenges to the emergency services. For more than 40 years WEBER RESCUE SYSTEMS has aligned to this trend and development with innovative and powerful rescue tools. We provide the right tools and equipment for any emergency situation. A comprehensive portfolio of accessories, our online-shop with many useful gadgets, tools and promotional items completes the range.

In addition to our innovative products we also provide educational and informative training courses from rescue specialists. Furthermore we offer workshop courses for testing and maintenance of our equipment including technical seminars with different topics. This gives us the great opportunity to collect

feedback, new ideas and innovations for and from our customers.

Digital solutions and applications are becoming increasingly important in the field of all emergency relief organizations.

Our target is to develop digital solutions for all emergency relief organizations to help and support their members, professionals as well as volunteers who have made it their business to take care of others.

Together with our customers in the fire service, THW, police, military and industry sectors, RESCUE DIGITAL develops individual and easy-to-use apps and software applications in the areas of alarms, administration, accident prevention and rescue services.

You can get the best overview of the many advantages of our systems during a personal product presentation at your own location. There you can discover the real advantages of WEBER RESCUE products.

LET'S CREATE FUTURE >

ENVIRONMENTAL MANAGEMENT ACCORDING TO ISO

The production of rescue equipment by WEBER RESCUE SYSTEMS is certified according to ISO 14001 and thus guarantees compliance with very high environmental criteria. Through sustainable environmental and energy management, environmental risks are reduced, environmental performance is made transparent and targeted improvement measures are derived.

"Sustainability is a very important topic for us. We are constantly working on optimizing our processes with regard to the environmental and energy targets we have set. The ISO 14001 and ISO 50001 certifications now show quite objectively that we meet very high requirements in this regard."

Bernhard Obermayr, Managing Director



www.weber-rescue.com
www.weber-rescue-shop.com



SMART FORCE
MORE THAN A RESCUE TOOL.

THE REVOLUTIONARY BATTERY TOOL SERIES

With the new SMART FORCE series, we herald a digital revolution in the rescue tool market. More speed, a powerful MILWAUKEE M18™ High Output™ battery-pack, intuitive design and numerous Smart Features packed into a robust and underwater capable housing. More than a rescue tool!



READY TO START!

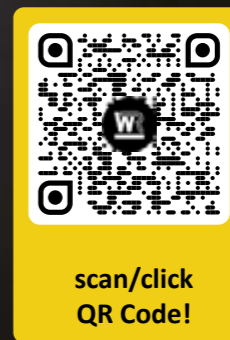

INNOVATIVE RESCUE TOOLS WITH SMART FEATURES

The new SMART-FORCE rescue tool series marks a milestone in rescue tool technology. Thanks to a further optimised drive, high-performance battery technology from MILWAUKEE and the use of smart additional functions, accident rescue with our battery-powered tools will be significantly faster and more efficient in the future. In addition to digitalisation, other features including underwater use, service and training are also taken into account in the new product series.

POW3R PUMP

- 3-stage-pump
- fastest and most powerful battery powered rescue tool on the market
- enormous power reserves for future vehicle technologies and materials
- patented, compact and maintenance-free motor

18V BATTERY

- powerful MILWAUKEE M18™ High Output™ battery pack
- one battery for all applications: 17 rescue tools and more than 200 compatible MILWAUKEE tools
- unbeatable value for money and security of supply

INTUITIVE

- central control panel that can be easily operated without having to reach around with thumb and index finger
- main working direction clearly identifiable visually and haptically
- all important operating parts in striking red
- pressure indicator shows whether e.g. a cutting operation has already been completed

UNDERWATER

- designed for use in the most extreme conditions
- robust, waterproof and dustproof housing according to IP 68
- certified to a depth of 3 m in fresh, salt or dirty water

CONNECT

- numerous Smart Features for tool operation and control
- patented theft protection with geofence function
- training mode for throttling the speed of the unit and recording live data - different working techniques can be practised more easily
- live Service Dashboard
- quickcheck/self-diagnosis function
- access to the digital world of WEBER RESCUE with further apps and digital solutions



THE REVOLUTIONARY BATTERY TOOL SERIES.

OUR TECHNOLOGIES

ADDITIONAL	Useful equipment for the whole rescue operation	PEELING	Inbuilt peeling function for peeling sheets
CHARGE	Li-Ion battery for independent working	PLUS	PLUS blade inserts easily changed blades
COAX	Hose-in-hose-system for easier handling	PUSH CONTROL	Push-Button-Control intuitive and sensitive operation
FORGED	Forged blades for the hardest applications	SINGLE	Single coupling coupling under pressure
GRIP	Tips with stainless steel spikes for extra grip	SPEED CONTROL	Intelligent switching technology increases working speed
HANDLE	360° Handle rotatable, adjustable, detachable	X-CHANGE	Connection point for more flexibility

Innovative SMOOTH CUT technology – Highest performance and low-stress cutting



- optimised blade geometry and new blade shape for even more cutting performance
- greater stability due to stronger central bolt and new lugs
- easy servicability and maintenance due to new securing and lubrication system on the central bolt

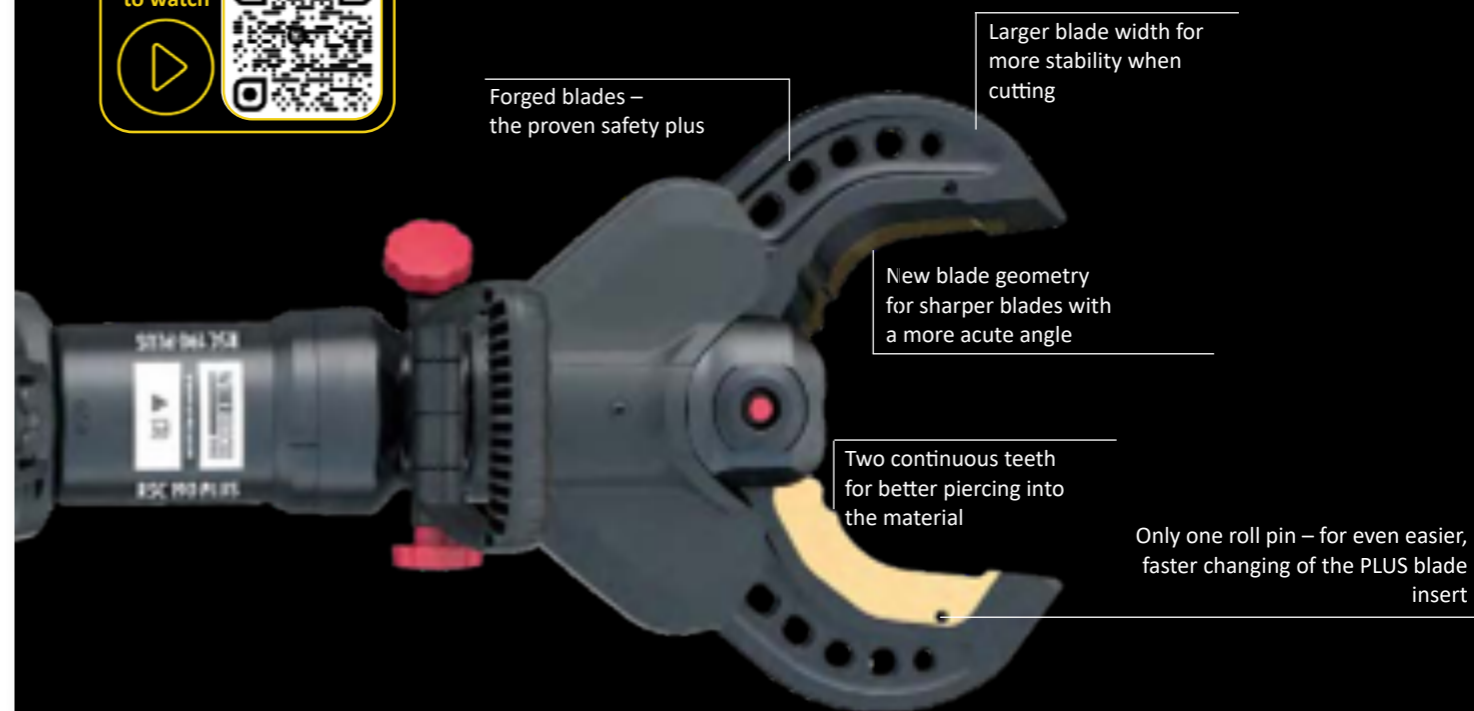

HYDRAULIC RESCUE TOOLS AND ACCESSORIES

	Specialised tools 52
	News and technologies 8
	Spreaders 10
	Cutters 14
	Combi tools 20
	Rescue rams 26
	Power Units 32
	Battery tools and accessories 38
	Additional battery equipment 46
	Lifting tools 54
	Stabilisation 58
	Glass management and protection shields 62
	Additional equipment 66
	Gloves for technical rescue 72
	Crash Recovery System® 73

PNEUMATIC RESCUE TOOLS AND ACCESSORIES

	Lifting bags 8 bar 74		Accessories for sealing systems 2.5 bar 83
	Lifting bags 10 bar 76		Gully sealing bags 86
	Lifting bags 12 bar 78		Collecting tank 87
	Lifting bag sets 80		Table of resistance 88
	Additional Equipment 81			
	Sealing Systems 2.5 bar 82			

TRAINING AND ALERTING

	Crash System 89		Crash System 94
---	---------------------	----------	---	---------------------	----------

RESCUE TECHNOLOGY IS GETTING SMART!

With the introduction of our new device series, smart functions are also integrated into the rescue device itself for the first time. The SMART-FORCE devices enable communication via WLAN/UMTS connection and offer numerous additional functions for device control and management within their own app, e.g. a pressure indicator, a training and anti-theft mode and the possibility to analyse the current device status.

However, the new smart features and advantages of the digital connection do not affect the main function of the rescue equipment in the slightest. SMART-FORCE tools remain first and foremost hydraulic rescue tools, which are made even better by the new functions and offer new advantages.



In order to be able to use the smart features of the SMART-FORCE equipment without restrictions via the web interface and app, it is necessary to register the tool online. This registration process activates the SIM card installed in the device, which enables data transmission.

At the same time, settings for the device and for different authorisation profiles can be stored via the app or the web interface. An explicit consent to privacy policy is required to register the tool and to use all functions.

You will find everything you need to know about the new SMART-FORCE rescue tools in a detailed FAQ on our website.



scan/click
QR Code!

SMART FEATURES

-  **WLAN and LTE (IoT)**
-  **Pressure indicator**
-  **GPS - easy to locate tool**
-  **Remaining runtime and battery status**
-  **Tool management**
-  **Safety stop**
-  **Authorisation profiles**
-  **Quicktest/Self-diagnostics**
-  **SMART-FORCE App**
-  **Anti-theft - easy to find tool**
-  **Tool status and telemetry**
-  **Training mode**
-  **Service information**

> SMART FEATURES ARE FREE FOR 3 YEARS WITH THE PURCHASE OF THE APPLIANCE INCLUDED. THESE CAN THEN BE ORDERED AT A LATER DATE.



SMART-FORCE
BY WEBER RESCUE SYSTEMS

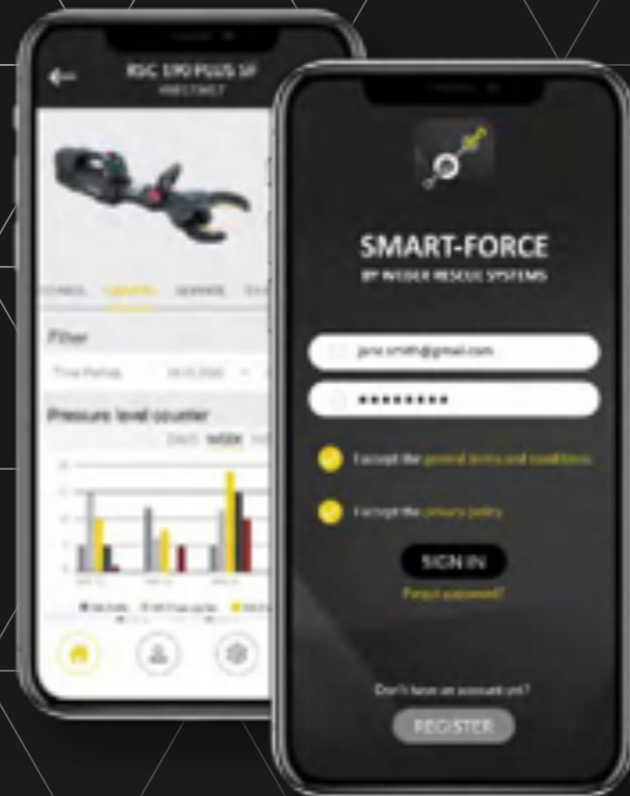

SPREADERS

Spreaders from the new range for biggest challenges

- detachable tips with integrated peeling function
- tips with interior and exterior spikes for extra grip
- spreader arms made of high-strength aluminium
- unique surface hardened areas on the spreader arms increases the working range
- wrap-round handle for easy handling and fast work
- all control elements are designed in high visibility and distinctive in red
- available as SMART-FORCE, E-FORCE3 or hose unit due to uniform separation point
- battery tools with new, efficient drive for higher speed
- battery not included

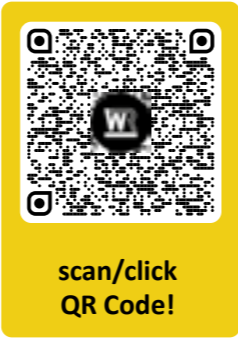

NEW SPREADER GENERATION



Extremely lightweight and slim design for even better handling

LET'S CREATE FUTURE



Spreader tips tips with interior and exterior spikes for extra grip

Wrap-round handle for easier handling

SP 50 BS

Spreader from the new range with completely new design

- spreader from the new range with completely new design
- lightest BS spreader in the world
- wide spreading width for all applications
- tips with interior and exterior spikes for extra grip
- peripheral grip for simpler handling and holding
- complies with BS class per EN13204
- available as SMART-FORCE, E-FORCE3 or hose unit due to uniform separation point



SP 50 BS



SP 50 BS E-FORCE3



SP 50 BS SMART-FORCE



- X-CHANGE
- PEELING
- PUSH CONTROL
- SINGLE
- GRIP

- X-CHANGE
- PEELING
- SPEED CONTROL
- CHARGE
- GRIP

- X-CHANGE
- LED LIGHTS
- UNDERWATER
- 18V BATTERY
- POW3R PUMP
- CONNECT
- GRIP
- PEELING

Spreading width	805 mm	805 mm	805 mm
Spreading force*	50 - 501 kN	50 - 501 kN	50 - 501 kN
Max. squeezing force	144 kN	144 kN	144.0 kN
Pulling width	680 mm	680 mm	680 mm
Max. pulling force	67 kN	67 kN	67 kN
EN class	BS50/805-17,0	BS50/805-20,9	BS50/805-21,8
Weight (ready to use**)	17.0 kg	20.9 kg	21.8 kg
Part no.	1090581	1091735	1100143

*In the working area

**E-FORCE: Weight incl. battery 5.0 Ah M28™ Red Li-Ion™ | SMART-FORCE: Weight incl. IP 68 battery cover and battery 8.0 Ah M18™ High Output™

SP 54 AS

Spreader from the new range with completely new design

- spreader from the new range with completely new design
- tips with interior and exterior spikes for extra grip
- peripheral grip for simpler handling and holding
- satisfies AS class per EN 13204
- available as SMART-FORCE, E-FORCE3 or hose unit due to uniform separation point



SP 54 AS



SP 54 AS E-FORCE3



SP 54 AS SMART-FORCE



- X-CHANGE
- PEELING
- PUSH CONTROL
- SINGLE
- GRIP

- X-CHANGE
- PEELING
- SPEED CONTROL
- CHARGE
- GRIP

- X-CHANGE
- LED LIGHTS
- UNDERWATER
- 18V BATTERY
- POW3R PUMP
- CONNECT
- GRIP
- PEELING

Spreading width	735 mm	735 mm	735 mm
Spreading force*	55 - 501 kN	55 - 501 kN	55 - 501 kN
Max. squeezing force	144 kN	144 kN	144.0 kN
Pulling width	620 mm	620 mm	620 mm
Max. pulling force	70 kN	70 kN	70 kN
EN class	AS55/735-16,8	AS55/735-20,7	AS55/735-21,6
Weight (ready to use**)	16.8 kg	20.7 kg	21.6 kg
Part no.	1089800	1091736	1101469

*In the working area

**E-FORCE: Weight incl. battery 5.0 Ah M28™ Red Li-Ion™ | SMART-FORCE: Weight incl. IP 68 battery cover and battery 8.0 Ah M18™ High Output™

SP 44 AS

Spreader from the new range with completely new design

- lightweight and slim construction
- fulfills AS standard
- the plastic grip with optimised gripping surface also insulates the equipment operator up to 1.000 Volts
- available as SMART-FORCE, E-FORCE3 or hose unit due to uniform separation point



SP 44 AS



SP 44 AS E-FORCE3



SP 44 AS SMART-FORCE



- X-CHANGE
- 360° HANDLE
- PEELING
- PUSH CONTROL
- SINGLE
- GRIP

- X-CHANGE
- 360° HANDLE
- PEELING
- SPEED CONTROL
- CHARGE
- GRIP

- X-CHANGE
- LED LIGHTS
- UNDERWATER
- 18V BATTERY
- POW3R PUMP
- CONNECT
- GRIP
- PEELING

	SP 44 AS	SP 44 AS E-FORCE3	SP 44 AS SMART-FORCE
Spreading width	610 mm	610 mm	610 mm
Spreading force*	44 - 857 kN	44 - 857 kN	44 - 857 kN
Max. squeezing force	149.0 kN	149.0 kN	149.0 kN
Pulling width	465 mm	465 mm	465 mm
Max. pulling force	68 kN	68 kN	68 kN
EN class	AS44/610-13,4	AS44/610-17,3	AS44/610-18,2
Weight (ready to use**)	13.4 kg	17.3 kg	18.2 kg
Part no.	1093667	1093703	1101468

*In the working area

**E-FORCE: Weight incl. battery 5.0 Ah M28™ Red Li-Ion™ | SMART-FORCE: Weight incl. IP 68 battery cover and battery 8.0 Ah M18™ High Output™

SP 84 CS



Spreader for hardest use

- compact design
- wrap-round handle for easy handling and efficient work
- as per EN13204

- PEELING
- PUSH CONTROL
- SINGLE
- GRIP

Spreading width	660 mm
Spreading force (in the working area)	82 - 680 kN
Max. squeezing force	129.0 kN
Pulling width	540 mm
Max. pulling force	93 kN
EN class	CS82/660-19,8
Weight	19.8 kg
Part no.	1093904

ACCESSORIES



Replacement tips	Weight	Part no.
SP 44 AS	0.6 kg	1091176
SP 50 BS, SP 54 AS	0.9 kg	1091849
SP 64 BS, SP 84 CS	1.0 kg	1090484

Chain sets	Weight	Part no.
SP 44 AS	13.8 kg	2819139
SP 50 BS, SP 54 AS	13.8 kg	571415
SP 64 BS, SP 84 CS	14.54 kg	1095147

Consisting of: 2 pcs. chain lock, 2 pcs. pulling chain 1.8 m long with hooks. The length of chains can easily be adjusted through a button at the chain lock. There is no need to hook or unhook anymore.

SP 64 BS

BS-Spreader from the new range with completely new design

- wrap-round handle for easy handling and efficient work
- complies with BS class per EN13204



Spreading width	820 mm
Spreading force (in the working area)	64 - 680 kN
Max. squeezing force	129.0 kN
Pulling width	702 mm
Max. pulling force	74 kN
EN class	BS64/820-20,0
Weight	20.0 kg
Part no.	1093902

- PEELING
- PUSH CONTROL
- SINGLE
- GRIP



CUTTERS

Modern rescue tools for cutting of modern vehicles

- blade shape suitable for toughest applications
- optional cutter blades with inserts made of high strength alloy
- lower maintenance cost (just change inserts instead of the complete blades)
- all control elements are designed in high visibility and distinctive in red
- available as SMART-FORCE, E-FORCE3 or hose unit due to uniform separation point
- with new, more efficient drive for higher speed
- battery not included



scan/click
QR Code!

REPLACEABLE BLADE INSERTS

Blade inserts protect the blade, particularly well suited to cutting modern vehicles with high-strength materials

Save costs
by only replacing
the blade inserts

PLUS-blade inserts
within 2 minutes they can
be replaced easily, even
on-scene during an incident

LET'S CREATE FUTURE

+ PLUS

RSC 170

Flexible, hose-bound cutting tool for rapid use, compatible with all power options

- SMOOTH CUT technology for smooth, low-stress and safe cutting behaviour
- high-strength, forged lightweight blades with optimised blade geometry for maximum safety with low weight
- available as SMART-FORCE, E-FORCE3 or hose unit due to uniform separation point

NEW!

RSC 170



RSC 170 E-FORCE3



RSC 170 SMART-FORCE



- SMOOTH CUT
- FORGED
- 360° HANDLE
- SINGLE
- X-CHANGE
- PUSH CONTROL

- SMOOTH CUT
- LED LIGHTS
- FORGED
- SPEED CONTROL
- 360° HANDLE
- CHARGE
- X-CHANGE

- SMOOTH CUT
- 360° HANDLE
- 18V BATTERY
- LED LIGHTS
- POW3R PUMP
- UNDERWATER
- CONNECT
- X-CHANGE
- FORGED

Opening width	175 mm	175 mm	175 mm
EN class	BC166I-14,3	BC166I-18,1	BC166I-19,1
EN cutting performance (EN 13204)	1J-2K-3I-4J-5J	1J-2K-3I-4J-5J	1J-2K-3I-4J-5J
NFPA class	A7-B8-C6-D8-E9-F4	A7-B8-C6-D8-E9-F4	A7-B8-C6-D8-E9-F4
Weight (ready to use**)	14.3 kg	18.1 kg	19.1 kg
Part no.	1099459	1102148	1101547

**E-FORCE: Weight incl. battery 5.0 Ah M28™ Red Li-Ion™ | SMART-FORCE: Weight incl. IP 68 battery cover and battery 8.0 Ah M18™ High Output™

RSC 170 PLUS

The RSC 170 PLUS has quickly replaceable blade inserts thanks to PLUS blade technology

- SMOOTH CUT technology for smooth, low-stress and safe cutting behaviour
- high-strength, forged lightweight blades with optimised blade geometry for maximum safety with low weight
- new PLUS blade inserts for even easier blade changes
- available as SMART-FORCE, E-FORCE3 or hose unit due to uniform separation point

NEW!

RSC 170 PLUS



RSC 170 PLUS E-FORCE3



RSC 170 PLUS SMART-FORCE



- SMOOTH CUT
- FORGED
- 360° HANDLE
- PLUS
- SINGLE
- X-CHANGE
- PUSH CONTROL

- SMOOTH CUT
- FORGED
- 360° HANDLE
- PLUS
- CHARGE
- X-CHANGE
- LED LIGHTS
- SPEED CONTROL

- SMOOTH CUT
- 360° HANDLE
- 18V BATTERY
- PLUS
- POW3R PUMP
- LED LIGHTS
- CONNECT
- UNDERWATER
- FORGED
- X-CHANGE

Opening width	175 mm	175 mm	175 mm
EN class	BC166I-15,4	BC166I-19,1	BC166I-20,1
EN cutting performance (EN 13204)	1J-2K-3I-4J-5J	1J-2K-3I-4J-5J	1J-2K-3I-4J-5J
NFPA class	A7-B8-C6-D8-E9-F4	A7-B8-C6-D8-E9-F4	A7-B8-C6-D8-E9-F4
Weight (ready to use**)	15.4 kg	19.1 kg	20.1 kg
Part no.	1101568	1102149	1101548

**E-FORCE: Weight incl. battery 5.0 Ah M28™ Red Li-Ion™ | SMART-FORCE: Weight incl. IP 68 battery cover and battery 8.0 Ah M18™ High Output™

RSC 190

Hose-bound cutter with single coupling for versatile application possibilities

- SMOOTH CUT technology for smooth, low-stress and safe cutting behaviour
- high-strength, forged lightweight blades with optimised blade geometry for maximum safety with low weight
- available as SMART-FORCE, E-FORCE3 or hose unit due to uniform separation point

NEW!

RSC 190



RSC 190 E-FORCE3



RSC 190 SMART-FORCE



- SMOOTH CUT
- FORGED
- 360° HANDLE
- SINGLE
- X-CHANGE
- PUSH CONTROL

- SMOOTH CUT
- LED LIGHTS
- FORGED
- SPEED CONTROL
- 360° HANDLE
- CHARGE
- X-CHANGE

- SMOOTH CUT
- 360° HANDLE
- 18V BATTERY
- LED LIGHTS
- POW3R PUMP
- UNDERWATER
- CONNECT
- X-CHANGE
- FORGED

Opening width	187 mm	187 mm	187 mm
EN class	BC187K-16,9	BC187K-20,6	BC187K-21,5
EN cutting performance (EN 13204)	1K-2K-3K-4K-5K	1K-2K-3K-4K-5K	1K-2K-3K-4K-5K
NFPA class	A8-B9-C7-D9-E9-F4	A8-B9-C7-D9-E9-F4	A8-B9-C7-D9-E9-F4
Weight (ready to use**)	16.9 kg	20.6 kg	21.5 kg
Part no.	1099319	1102150	1101549

**E-FORCE: Weight incl. battery 5.0 Ah M28™ Red Li-Ion™ | SMART-FORCE: Weight incl. IP 68 battery cover and battery 8.0 Ah M18™ High Output™



RSC 190 PLUS

Versatile cutter with high cutting performance

- SMOOTH CUT technology for smooth, low-stress and safe cutting behaviour
- high-strength, forged lightweight blades with optimised blade geometry for maximum safety with low weight
- new PLUS blade inserts for even easier blade changes
- available as SMART-FORCE, E-FORCE3 or hose unit due to uniform separation point

NEW!

RSC 190 PLUS



RSC 190 PLUS E-FORCE3



RSC 190 PLUS SMART-FORCE



- SMOOTH CUT
- FORGED
- 360° HANDLE
- PLUS
- SINGLE
- X-CHANGE
- PUSH CONTROL

- SMOOTH CUT
- FORGED
- 360° HANDLE
- PLUS
- CHARGE
- X-CHANGE
- LED LIGHTS
- SPEED CONTROL

- SMOOTH CUT
- 18V BATTERY
- POW3R PUMP
- CONNECT
- FORGED
- 360° HANDLE
- PLUS
- LED LIGHTS
- UNDERWATER
- X-CHANGE

Opening width	187 mm	187 mm	187 mm
EN class	BC187K-18,0	BC187K-21,7	BC187K-22,7
EN cutting performance (EN 13204)	1K-2K-3K-4K-5K	1K-2K-3K-4K-5K	1K-2K-3K-4K-5K
NFPA class	A8-B9-C7-D9-E9-F4	A8-B9-C7-D9-E9-F4	A8-B9-C7-D9-E9-F4
Weight	18.0 kg	21.7 kg	22.7 kg
Part no.	1101569	1102151	1101550

**E-FORCE: Weight incl. battery 5.0 Ah M28™ Red Li-Ion™ | SMART-FORCE: Weight incl. IP 68 battery cover and battery 8.0 Ah M18™ High Output™



RSC 200

Powerful cutting tool with outstanding cutting performance

- SMOOTH CUT technology for smooth, low-stress and safe cutting behaviour
- high-strength, forged lightweight blades with optimised blade geometry for maximum safety
- available as SMART-FORCE, E-FORCE3 or hose unit due to uniform separation point

RSC 200



RSC 200 E-FORCE3



RSC 200 SMART-FORCE



NEW!

- SMOOTH CUT
- FORGED
- 360° HANDLE
- SINGLE
- X-CHANGE
- PUSH CONTROL

- SMOOTH CUT
- LED LIGHTS
- FORGED
- SPEED CONTROL
- 360° HANDLE
- CHARGE
- X-CHANGE

- SMOOTH CUT
- 360° HANDLE
- 18V BATTERY
- LED LIGHTS
- POW3R PUMP
- UNDERWATER
- CONNECT
- X-CHANGE
- FORGED

Opening width	202 mm	202 mm	202 mm
EN class	CC202K-21,0	CC202K-24,7	CC202K-25,7
EN cutting performance (EN 13204)	1K-2K-3K-4K-5K	1K-2K-3K-4K-5K	1K-2K-3K-4K-5K
NFPA class	A9-B9-C9-D9-E9-F5	A9-B9-C9-D9-E9-F5	A9-B9-C9-D9-E9-F5
Weight (ready to use**)	21.0 kg	24.7 kg	25.7 kg
Part no.	1098473	1102152	1101551

**E-FORCE: Weight incl. battery 5.0 Ah M28™ Red Li-Ion™ | SMART-FORCE: Weight incl. IP 68 battery cover and battery 8.0 Ah M18™ High Output™

RSC F7

World's first F7 cutter to NFPA standard

- handles the highest cutting class according to NFPA
- cuts the hardest material without problems
- high-strength, forged lightweight blades with optimised blade geometry for maximum safety
- available as SMART-FORCE, E-FORCE3 or hose unit due to uniform separation point

RSC F7



RSC F7 E-FORCE3



RSC F7 SMART-FORCE



NEW!

- FORGED
- X-CHANGE
- FORGED
- LED LIGHTS
- 18V BATTERY
- 360° HANDLE
- PUSH CONTROL
- 360° HANDLE
- SPEED CONTROL
- POW3R PUMP
- LED LIGHTS
- PLUS
- CHARGE
- CONNECT
- UNDERWATER
- SINGLE
- X-CHANGE
- FORGED
- X-CHANGE

Opening width	300 mm	300 mm	300 mm
EN class	CC268K-23,3	CC268K-26,9	CC268K-27,7
EN cutting performance (EN 13204)	1K-2K-3K-4K-5K	1K-2K-3K-4K-5K	1K-2K-3K-4K-5K
NFPA class	A9-B9-C9-D9-E9-F7	A9-B9-C9-D9-E9-F7	A9-B9-C9-D9-E9-F7
Weight (ready to use**)	23.3 kg	26.9 kg	27.7 kg
Part no.	1101567	1102153	1101553

**E-FORCE: Weight incl. battery 5.0 Ah M28™ Red Li-Ion™ | SMART-FORCE: Weight incl. IP 68 battery cover and battery 8.0 Ah M18™ High Output™

S 50

Compact cutting device for low-tension cutting

- no uncontrolled movement when object being cut
- can be used in confined spaces, e.g. in the footwell of crashed vehicles
- extremely lightweight, single-handed operation possible



- SINGLE
- PUSH CONTROL
- FORGED

Opening width	50 mm
EN class	AC50B-4,2
EN cutting performance (EN 13204)	1C-2D-3B
NFPA class	A4-B3-C2-D4-E3
Weight	4.2 kg
Part no.	1093906

REPLACEMENT BLADE

	Part. no.
Cutter blade for S 50 upper blade	3863670
Cutter blade for S 50 lower blade	3863689
Cutter blade for RSC 170	1099451
Cutter blade for RSC 190	1099309
Cutter blade for RSC 200	1099765
Cutter blade for RSC F7	1101226
Blade insert for RSC 170 PLUS / RSC 190 PLUS (1 pc)	1099753
Blade insert for RSC 170 PLUS / RSC 190 PLUS (2 pc in pouch)	1103455
Cutter blade with insert for RSC 170 PLUS	1099758
Cutter blade with insert for RSC 190 PLUS	1099396

COMBI TOOLS

All with one tool - cutting, spreading, pressing and pulling!

- combining tools means less space and weight
- grid-like structure blades, re-sharpenable and with a notch for cutting round bars
- 360° rotating and folding high durable fibre-reinforced plastic grip insulates the equipment operator up to 1,000 Volts
- all control elements are designed in high visibility and distinctive in red
- can be combined with chain set and mechanical rescue cylinders
- available as SMART-FORCE, E-FORCE3 or hose unit due to uniform separation point
- battery tools with new, more efficient drive for higher speed
- battery not included



SPS 270 MK2

Extremely lightweight combi tool

- extremely light combi tool
- grid-like structure blades, re-sharpenable and with a notch for cutting round bars
- with connection point for conversion to E-FORCE3/SMART-FORCE battery tool



SPS 270 MK2



SPS 270 MK2 E-FORCE3



SPS 270 MK2 SMART-FORCE



- X-CHANGE
- 360° HANDLE
- FORGED
- PUSH CONTROL
- SINGLE

- X-CHANGE
- 360° HANDLE
- FORGED
- SPEED CONTROL
- CHARGE

- 18V BATTERY
- 360° HANDLE
- POW3R PUMP
- LED LIGHTS
- CONNECT
- UNDERWATER
- FORGED
- X-CHANGE

Spreading width	270 mm	270 mm	270 mm
Spreading force*	31 - 591 kN	31 - 591 kN	31 - 591 kN
Opening	221 mm	221 mm	221 mm
Pulling width (with adapter)	395 mm	395 mm	395 mm
Max. pulling force	36 kN	36 kN	36 kN
EN class (EN 13204)	BK31/270G-9,7	BK31/270G-13,6	BK31/270G-14,6
EN cutting class (EN 13204)	1H-2G-3G-4H-5G	1H-2G-3G-4H-5G	1H-2G-3G-4H-5G
NFPA class	A6-B7-C6-D7-E7-F3	A6-B7-C6-D7-E7-F3	A6-B7-C6-D7-E7-F3
Weight (ready for use**)	9.7 kg	13.6 kg	14.6 kg
Part no.	1093263	1093515	1101470

*In the working area

**E-FORCE: Weight incl. battery 5.0 Ah M28™ Red Li-Ion™ | SMART-FORCE: Weight incl. IP 68 battery cover and battery 8.0 Ah M18™ High Output™

SPS 360 MK2

Versatile combi tool

- serrated blades bite firmly
- lightweight, yet strong spreading and cutting force
- available as SMART-FORCE, E-FORCE3 or hose unit due to uniform separation point



SPS 360 MK2



SPS 360 MK2 E-FORCE3



SPS 360 MK2 SMART-FORCE



- X-CHANGE
- 360° HANDLE
- FORGED
- PUSH CONTROL
- SINGLE

- X-CHANGE
- 360° HANDLE
- FORGED
- SPEED CONTROL
- CHARGE

- 18V BATTERY
- 360° HANDLE
- POW3R PUMP
- LED LIGHTS
- CONNECT
- UNDERWATER
- FORGED
- X-CHANGE

Spreading width	360 mm	360 mm	360 mm
Spreading force*	36 - 783 kN	36 - 783 kN	36 - 783 kN
Opening	285 mm	285 mm	285 mm
Pulling width (with adapter)	440 mm	440 mm	440 mm
Max. pulling force	53 kN	53 kN	53 kN
EN class (EN 13204)	CK36/360I-14,2	CK36/360I-18,1	CK36/360I-18,9
EN cutting class (EN 13204)	1I-2K-3J-4K-5J	1I-2K-3J-4K-5J	1I-2K-3J-4K-5J
NFPA class	A7-B8-C7-D9-E8-F5	A7-B8-C7-D9-E8-F5	A7-B8-C7-D9-E8-F5
Weight (ready for use**)	14.2 kg	18.1 kg	18.9 kg
Part no.	1096646	1096647	1101471

*In the working area

**E-FORCE: Weight incl. battery 5.0 Ah M28™ Red Li-Ion™ | SMART-FORCE: Weight incl. IP 68 battery cover and battery 8.0 Ah M18™ High Output™

SPS 370 MK2

Versatile combi tool

- serrated blades bite firmly
- high spreading and cutting and cutting forces - but lightweight
- becomes a fully-fledged cutting tool through replaceable tips
- can be combined with chain set, door opener tips or mechanical ram
- rotating and folding handle for optimal handling
- available as SMART-FORCE, E-FORCE3 or hose unit due to uniform separation point

NEW!

SPS 370 MK2



SPS 370 MK2 E-FORCE3



SPS 370 MK2 SMART-FORCE



- X-CHANGE
- 360° HANDLE
- FORGED
- PUSH CONTROL
- SINGLE

- X-CHANGE
- 360° HANDLE
- FORGED
- SPEED CONTROL
- CHARGE

- 18V BATTERY
- 360° HANDLE
- POW3R PUMP
- LED LIGHTS
- CONNECT
- UNDERWATER
- FORGED
- X-CHANGE

Spreading width	370 mm	370 mm	370 mm
Spreading force*	35 - 783 kN	35 - 783 kN	35 - 783 kN
Opening	295 mm	295 mm	295 mm
Pulling width (with adapter)	405 mm	405 mm	405 mm
Max. pulling force	57 kN	57 kN	57 kN
EN class (EN 13204)	CK35/370H-15,4	CK35/370H-19,2	CK35/370H-20,1
EN cutting class (EN 13204)	11-2J-3H-4J-5I	11-2J-3H-4J-5I	11-2J-3H-4J-5I
NFPA class	A7-B8-C7-D8-E8-F5	A7-B8-C7-D8-E8-F5	A7-B8-C7-D8-E8-F5
Weight (ready for use**)	15.4 kg	18.2 kg	20.1 kg
Part no.	1096648	1096649	1101472

*In the working area

**E-FORCE: Weight incl. battery 5.0 Ah M28™ Red Li-Ion™ | SMART-FORCE: Weight incl. IP 68 battery cover and battery 8.0 Ah M18™ High Output™

SPS 400 MK2

Versatile combi tool with high cutting and spreading forces

- long life and better cutting performance due to forged and lightweight high strength blades
- serrated blades bite firmly
- becomes a fully-fledged cutting tool through replaceable tips
- can be combined with chain set, door opener tips or mechanical ram
- rotating and folding handle for optimal handling
- available as SMART-FORCE, E-FORCE3 or hose unit due to uniform separation point

NEW!

SPS 400 MK2



SPS 400 MK2 E-FORCE3



SPS 400 MK2 SMART-FORCE



- X-CHANGE
- 360° HANDLE
- FORGED
- PUSH CONTROL
- SINGLE

- X-CHANGE
- 360° HANDLE
- FORGED
- SPEED CONTROL
- CHARGE

- 18V BATTERY
- 360° HANDLE
- POW3R PUMP
- LED LIGHTS
- CONNECT
- UNDERWATER
- FORGED
- X-CHANGE

Spreading width	405 mm	405 mm	405 mm
Spreading force*	35 - 1071 kN	35 - 1071 kN	35 - 1071 kN
Opening	343 mm	343 mm	343 mm
Pulling width (with adapter)	450 mm	450 mm	450 mm
Max. pulling force	58 kN	58 kN	58 kN
EN class (EN 13204)	CK35/405I-17,2	CK35/405I-21,0	CK35/405I-21,7
EN cutting class (EN 13204)	11-2K-3J-4K-5J	11-2K-3J-4K-5J	11-2K-3J-4K-5J
NFPA class	A7-B9-C7-D9-E9-F6	A7-B9-C7-D9-E9-F6	A7-B9-C7-D9-E9-F6
Weight (ready for use**)	17.2 kg	21.0 kg	21.7 kg
Part no.	1096650	1092611	1100144

*In the working area

**E-FORCE: Weight incl. battery 5.0 Ah M28™ Red Li-Ion™ | SMART-FORCE: Weight incl. IP 68 battery cover and battery 8.0 Ah M18™ High Output™



SPS 480 MK2

Extremely powerful combi tool with maximum cutting and spreading force and revolutionary smart features

- very large opening width of 480 mm
- re-shapeable, trussed grid structure blades with a notch for cutting round bars
- becomes a fully-fledged cutting tool through replaceable tips
- can be combined with chain set, door opener tips or mechanical ram
- rotating and folding handle for optimal handling
- available as SMART-FORCE, E-FORCE3 or hose unit due to uniform separation point

NEW!

SPS 480 MK2



SPS 480 MK2 E-FORCE3



SPS 480 MK2 SMART-FORCE



- | | | | | | |
|--------------|---------------|---------------|-------------|-------------|-------------|
| X-CHANGE | 360° HANDLE | X-CHANGE | 360° HANDLE | 18V BATTERY | 360° HANDLE |
| FORGED | SPEED CONTROL | FORGED | LED LIGHTS | POW3R PUMP | LED LIGHTS |
| PUSH CONTROL | SPEED CONTROL | SPEED CONTROL | UNDERWATER | CONNECT | UNDERWATER |
| SINGLE | CHARGE | CHARGE | FORGED | X-CHANGE | X-CHANGE |

Spreading width	480 mm	480 mm	480 mm
Spreading force*	45 - 1600 kN	45 - 1600 kN	45 - 1600 kN
Opening	402 mm	402 mm	402 mm
Pulling width (with adapter)	525 mm	525 mm	525 mm
Max. pulling force	78 kN	78 kN	78 kN
EN class (EN 13204)	CK45/480K-21,0	CK45/480K-24,7	CK45/480K-25,6
EN cutting class (EN 13204)	1K-2K-3K-4K-5K	1K-2K-3K-4K-5K	1K-2K-3K-4K-5K
NFPA class	A8-B9-C9-D9-E9-F7	A8-B9-C9-D9-E9-F7	A8-B9-C9-D9-E9-F7
Weight (ready for use**)	21.0 kg	24.7 kg	25.6 kg
Part no.	1098258	1099153	1101554

*In the working area
**E-FORCE: Weight incl. battery 5.0 Ah M28™ Red Li-Ion™ | SMART-FORCE: Weight incl. IP 68 battery cover and battery 8.0 Ah M18™ High Output™

HANDVARIO RIT-TOOL



- FORGED
- UNDERWATER

Manually operated combination device with integrated hydraulic drive

- space-saving and can be used anywhere
- low weight
- head section can be rotated 360° for optimum work

Spreading width	280 mm
Spreading force*	25 - 1175 kN
Opening	215 mm
Pulling width (with adapter)	320 mm
Max. pulling force	40 kN
EN class (EN 13204)	K25-G-M
EN cutting class (EN 13204)	1H-2G-3G-4H-5G
NFPA class	A6-B7-C6-D7-E7-F3
Weight	11.1 kg
Part no.	1100441

*In the working area

REPLACEABLE TIPS AND ACCESSORIES

replacement blade (arm) for	weight	part-no.
SPS 270 MK2 and SPS 270 H	1.2 kg	1084095
SPS 360 MK2	2.4 kg	1091442
SPS 370 MK2	1.8 kg	1091443
SPS 400 MK2	2.2 kg	1092292
SPS 480 MK2	2.9 kg	1085938
RIT-Tool Handvario	2.1 kg	1084096
spreader tips (2 pcs needed)	weight	part-no.
SPS 370 MK2, SPS 400 MK2, SPS 480 MK2, RIT-Tool Handvario	0.8 kg	1050616
Pulling device, with pin for fastening chains on to blades (arms). 2 pcs needed	weight	part-no.
SPS 270 MK2 und SPS 270 H	1.4 kg	1103553
SPS 360 MK2	2.2 kg	2835746
SPS 370 MK2, SPS 400 MK2, SPS 480 MK2, RIT-Tool Handvario	1.4 kg	2836033
chain set	weight	part-no.
für SPS 270 MK2, SPS 360 MK2, SPS 370 MK2, SPS 400 MK2, SPS 480 MK2, RIT-TOOL, SPS 270 H	13.8 kg	2819139
rescue ram for RZM 740	weight	part-no.
SPS 270 MK2, SPS 360MK2, SPS 270 H	6.8 kg	1056478
rescue ram for RZM CRT	weight	part-no.
SPS 370 MK2, SPS 400 MK2, RIT-Tool Handvario	7.8 kg	1094618

SPS 270 H HANDVARIO



- 360° HANDLE
- LIGHTWEIGHT

Manually operated combination device with integrated hydraulic drive

- space-saving and can be used anywhere
- low weight
- head section can be rotated 360° for optimum work

Spreading width	270 mm
Spreading force*	26 - 534 kN
Opening	221 mm
Pulling width (with adapter)	380 mm
Max. pulling force	32 kN
EN class (EN 13204)	K25G-M
EN cutting class (EN 13204)	1H-2G-3G-4H-5G
NFPA class	A6-B7-C6-D7-E7
Weight	9.8 kg
Part no.	1084065

*In the working area



RESCUE RAMS

Single-stage

- various accessories available, such as adapters and chain sets
- optimum length matching – overlapping length of the entire range of rams
- with movable head, which can still be rotated under load

Telescopic rescue rams

- double-acting telescopic ram made of reliable high-quality steel or high-strength aluminium
- special multi-stage-construction allows extra extended and retracted length

All rescue rams from WEBER RESCUE SYSTEMS have the remaining length (DISTANCE) visible laser-etched on the piston rod. This early warning system enables you to decide right away whether the ram you are currently using is long enough for the job or whether a longer ram must be prepared and used. A real time improvement!

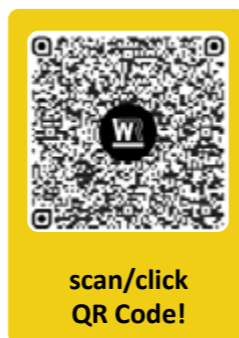

INTEGRATED REMAINING LENGTH MARKING



Indicates the last 20 centimetres until full extension

Remaining length marks laser-etched every 5 cm (2 in) on the piston rod

Up to four circumferential rings depending on type of cylinder

Inch and Centimetre markings around piston rod

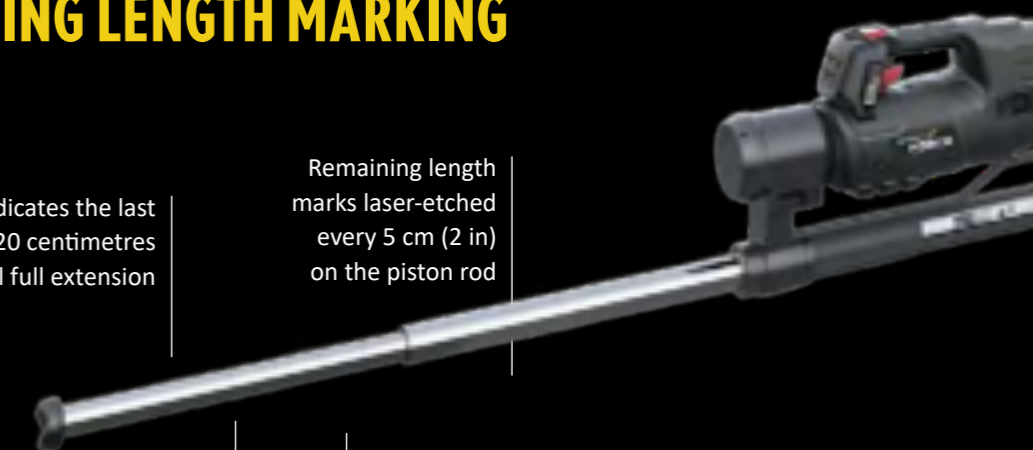

Single-stage rescue ram for pushing and pulling

- length from 530 – 1640 mm

RZ 1-850



RZ 2-1290



RZ 3-1640



- PUSH CONTROL
- SINGLE
- DISTANCE

- PUSH CONTROL
- SINGLE
- DISTANCE

- PUSH CONTROL
- SINGLE
- DISTANCE

Pushing force	137 kN	137 kN	137 kN
Pulling force	24 kN	24 kN	24 kN
Closed length	530 mm	750 mm	1100 mm
Piston stroke 1. st.	320 mm	540 mm	540 mm
Extended length	850 mm	1290 mm	1640 mm
EN class	R137-320-11,5	R137-540-16,2	R137-540-19,1
Weight	11.5 kg	16.2 kg	19.1 kg
Part no.	5933803	5933781	5933765

Single stage rescue ram for working inside the vehicle cabin

- most suitable ram for severely deformed vehicle interior
- lightweight and handy due to the small-diameter ram body
- extreme final extended length of 1810 mm

RZ 1-1810 CROSSRAMMER



- DISTANCE
- SINGLE
- PUSH CONTROL

Pushing force	36 kN	111 kN	111 kN
Closed length	990 mm	540 mm	540 mm
Piston stroke 1. stage	820 mm	368 mm	368 mm
Extended length	1810 mm	908 mm	908 mm
Weight (ready to use**)	13.5 kg	15.7 kg	18.4 kg
Part no.	1077052	1075272	1103096

**E-FORCE: Weight incl. battery 5.0 Ah M28™ Red Li-Ion™ | SMART-FORCE: Weight incl. IP 68 battery cover and battery 8.0 Ah M18™ High Output™

RZ 1-910

Single-stage, battery-operated rescue ram for pushing

- for better mobility and flexibility in use
- battery not included

RZ 1-910 E-FORCE2



RZ 1-910 SMART-FORCE



- DISTANCE
- CHARGE

- 18V BATTERY
- DISTANCE
- POW3R PUMP
- LED LIGHTS
- CONNECT
- UNDERWATER



RZT 2-600

Compact rescue ram for working in most confined spaces

- extending to the final length of 600 mm without any interruption
- for use e.g. in footwells
- RC7 with remote control unit

RZT 2-600



RZT 2-600 RC7



NEW!

- III DISTANCE
- S SINGLE
- ⚙ PUSH CONTROL

- III DISTANCE
- S SINGLE
- ⚙ PUSH CONTROL

Pushing force (1./2. stage)	189/99 kN	189/99 kN
Closed length	300 mm	300 mm
Piston stroke (1./2. stage)	165/135 mm	165/135 mm
Extended length	600 mm	600 mm
EN class	TR189/165-99/135-9,1	TR189/165-99/135-10,4
Weight	9.1 kg	10.4 kg
Part no.	5936934	5936934RC7

RZT 2-1170

Telescopic rescue ram with a compact retracted insertion size and an extreme extended length due to our multi-stage construction

- extending to the final length of 1170 mm without any interruption

RZT 2-1170



RZT 2-1170 E-FORCE2



NEW!

RZT 2-1170 SMART-FORCE



NEW!

- III DISTANCE
- S SINGLE
- ⚙ PUSH CONTROL

- III DISTANCE
- ⚡ CHARGE

- 🔋 18V BATTERY
- ⚙ POW3R PUMP
- 🔌 CONNECT
- III DISTANCE
- 💡 LED LIGHTS
- 🌊 UNDERWATER

Pushing force (1./2. stage)	189/99 kN	189/99 kN	189/99 kN
Closed length	540 mm	540 mm	540 mm
Piston stroke (1./2. stage)	360/270 mm	360/270 mm	360/270 mm
Extended length	1170 mm	1170 mm	1170 mm
EN class	TR189/360-99/270-15,0	TR189/360-99/270-20,4	TR189/360-99/270-21,8
Weight (ready to use**)	15.0 kg	20.4 kg	21.8 kg
Part no.	1050149	1088997	1103095

**E-FORCE: Weight incl. battery 5.0 Ah M28™ Red Li-Ion™ | SMART-FORCE: Weight incl. IP 68 battery cover and battery 8.0 Ah M18™ High Output™

RZT 2-775

Compact rescue ram for working in the tightest of spaces

- extending to the final length of 775 mm without any interruption
- for use e.g. in footwells



- III DISTANCE
- S SINGLE
- ⚙ PUSH CONTROL

Pushing force (1./2. stage)	189/99 kN
Closed length	395 mm
Piston stroke (1./2. stage)	210/170 mm
Extended length	775 mm
EN class	TR189/210-99/170-11,3
Weight	11.3 kg
Part no.	5931401

RZT 3-1310 XL

High-performance telescopic ram with 3-stage design

- large piston stroke of 830 mm
- weight-saving ram body made of high quality aluminium alloy



- III DISTANCE
- S SINGLE
- ⚙ PUSH CONTROL

Pushing force	265/130/45 kN
Closed length	480 mm
Piston stroke 1. stage	326/285/218 mm
Extended length	1310 mm
Weight	17.0 kg
Part no.	5934133

RZT 2-1360

Telescopic battery-powered rescue ram with a compact retracted insertion size and an extreme extended length due to our multi-stage construction

- extending to the final length of 1360 mm without any interruption
- battery not included

RZT 2-1360 E-FORCE2



RZT 2-1360 SMART-FORCE



NEW!

- III DISTANCE
- ⚡ CHARGE

- ⚡ 18V BATTERY
- ⚙️ POW3R PUMP
- 🔗 CONNECT
- III DISTANCE
- 💡 LED LIGHTS
- 🌊 UNDERWATER

Pushing force (1./2. stage)	108/62 kN	108/62 kN
Closed length	587 mm	587 mm
Piston stroke (1./2. stage)	428/372 mm	428 /372 mm
Extended length	1387 mm	1387 mm
EN class	TR108/428-62/372-20,1-E-I	TR108/428-62/372-21,4-E-I
Weight (ready to use**)	20.1 kg	21.4 kg
Part no.	1078342	1100145

**E-FORCE: Weight incl. battery 5.0 Ah M28™ Red Li-Ion™ | SMART-FORCE: Weight incl. IP 68 battery cover and battery 8.0 Ah M18™ High Output™

RZT 2-1500

Telescopic rescue ram with a compact retracted insertion size and an extreme extended length due to our multi-stage construction

- extending to the final length of 1500 mm without any interruption

RZT 2-1500



RZT 2-1500 E-FORCE2



RZT 2-1500 SMART-FORCE



- III DISTANCE
- ⚙️ SINGLE
- 👉 PUSH CONTROL

- III DISTANCE
- ⚡ CHARGE

- ⚡ 18V BATTERY
- ⚙️ POW3R PUMP
- 🔗 CONNECT
- III DISTANCE
- 💡 LED LIGHTS
- 🌊 UNDERWATER

Pushing force (1./2. stage)	189/99 kN	108/62 kN	108 /62 kN
Closed length	650 mm	700 mm	700 mm
Piston stroke (1./2. stage)	470/380 mm	428/372 mm	428/372 mm
Extended length	1500 mm	1500 mm	1500 mm
EN class	TR189/470-99/380-17,8	TR108/428-62/372-21,4	TR108/428-62/372-22,7-E-I
Weight (ready to use**)	17.8 kg	21.4 kg	22.7 kg
Part no.	1050041	1081519	1099389

**E-FORCE: Weight incl. battery 5.0 Ah M28™ Red Li-Ion™ | SMART-FORCE: Weight incl. IP 68 battery cover and battery 8.0 Ah M18™ High Output™

RZT 2-1500 XL

Extra-strong rescue ram for the highest demands

- extending to the final length of 1500 mm without any interruption
- weight-saving ram body made of high quality aluminium alloy



- III DISTANCE
- ⚙️ SINGLE
- 👉 PUSH CONTROL

Pushing force (1./2. stage)	265/130 kN
Closed length	650 mm
Piston stroke (1./2. stage)	445/407 mm
Extended length	1500 mm
EN class	TR269/445-130/407-20,7
Weight	20.7 kg
Part no.	5932025

ACCESSORIES

	weight	part-no.
Base support front	5.6 kg	1824333
Base support back	9.0 kg	1824341
Sill support	12.3 kg	1085337
Rim adapter set back wheel	19.6 kg	2852144
Rim adapter set back and front wheel	30.7 kg	2854082
chain set	weight	part-no.
for RZ 1-3 und SP 43 L/49/60	13.8 kg	2819139
Adapter for chain set ID 2819139 (2 pcs. required)	0.8 kg	3847900
Accessory set RZ 1, 2 und 3 (different pushing heads +storage box)	6.5 kg	1083316
extensions	weight	part-no.
for RZT 2-600 and RZT 2-775	3.5 kg	3864588
for RZ 1-850		
Extension 250 mm	2.0 kg	1058482
Extension 175 mm	2.6 kg	3838579
Extension 250 mm	3.0 kg	1062442

RIT-TOOL

Flexible specialized tool for RAPID INTERVENTION TEAMS to provide quick forcible entry

- fully-featured battery combi tool with interchangeable tips depending on the application e.g. breaking doors and windows, cutting round steel and chains, lifting of loads, pulling obstacles, opening of vehicles (extrication)
- extremely high cutting and spreading forces
- pulling possible with optional pulling attachments
- free set composition possible
- rotating and folding handle for optimal handling

RIT-TOOL E-FORCE3



RIT-TOOL SMART-FORCE



NEW!



scan/click
QR Code!

IP-BAG E-FORCE

NEW!



Protective cover for underwater use of E-FORCE battery devices

- enables the use of battery-powered rescue devices under water
- additionally protects against dirt and contamination
- simple and fast application as well as preparation of the devices after an underwater use
- furthermore excellent fingertip control of the control rocker
- automatic pressure relief valve
- scope of delivery including storage bag
- two available sizes for a wide range of battery devices (scan QR Code)



	IP-BAG SMALL (grey)	IP-BAG LARGE (green)
IP-class	IP 58	IP 58
Permissible depth	< 10 m	< 10 m
Part no.	1101496	1101497

360° HANDLE

FORGED

SPEED CONTROL

CHARGE

360° HANDLE

FORGED

18V BATTERY

LED LIGHTS

UNDERWATER

POW3R PUMP

CONNECT

Opening width	215 mm	215 mm
EN-class	AC140H-13,3	AC140H-14,2
EN cutting class (EN 13204)	1H-2H-3H-4H-5H	1H-2H-3H-4H-5H
NFPA class	A6-B7-C6-D7-E7-F3	A6-B7-C6-D7-E7-F3
Weight (ready to use**)	13.3 kg	14.2 kg
Part no.	1093377	1101159

**E-FORCE: Weight incl. battery 5.0 Ah Red Li-Ion™ | SMART-FORCE: Weight incl. IP 68 battery cover and battery 8.0 Ah M18™ High Output™

REPLACEABLE TIPS AND ACCESSORIES

TIPP!



Mechanical Rescue Ram
RZM CRT
Part no. 1094618BLK

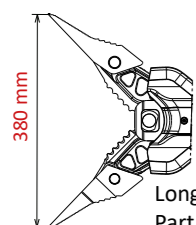

Long tip
Part no. 1051896

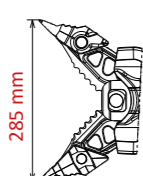

Spreader tip
Part no. 1050616

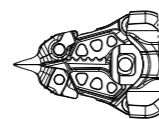

Door opener tip
Part no. 1096859

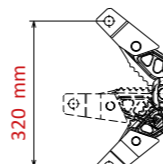

Pulling adapter
Part no. 286033

	Weight	Part. no
Replacement blade (arm)	2.1 kg	1063315
Long tip (2 pieces required)	1.2 kg	1051896
Spreader tip (2 pieces required)	0.7 kg	1050616
Door opener tip (2 pieces required)	0.9 kg	1096859
Chain set	13.8 kg	2819139
Pulling attachment (2 pieces required)	1.4 kg	2836033
Mechanical rescue ram RZM CRT Black	7.8 kg	1094618BLK

IP 68 BATTERYCOVER SMART-FORCE



Robust, waterproof and dustproof housing for underwater use of SMART-FORCE units

- Suitable for fresh, salt or dirty water
- thus also suitable for extreme conditions such as floods or vehicle recovery under water
- conversion for underwater use in a few simple steps
- all SMART-FORCE battery rescue tools come with an IP 68 battery cover and an IP 54 battery cover for 5.5 Ah and 8 Ah M18™ High Output™ batteries.

INCLUDED IN THE STANDARD SCOPE OF DELIVERY FOR SMART-FORCE DEVICES



TRANSPORT CASE



Robust PELI 1740 case for transport and storage of E-FORCE/SMART-FORCE rescue tools

- with tailored foam insert
- suitable for air transport thanks to a fully automatic pressure equalisation valve

Suitable for:

RIT-Tool E-FORCE/SMART-FORCE	SP 44 AS E-FORCE/SMART-FORCE
SPS 270 MK2 E-FORCE/SMART-FORCE	RSC 190 (PLUS) E-FORCE/SMART-FORCE
SPS 360 MK2 E-FORCE/SMART-FORCE	RSC 170 (PLUS) E-FORCE/SMART-FORCE
SPS 370 MK2 E-FORCE/SMART-FORCE	RSX 160 E-FORCE
SPS 400 MK2 E-FORCE/SMART-FORCE	RSU 180 PLUS E-FORCE

	Weight	Part no.
Transport case for E-FORCE/SMART FORCE battery tools	12.5 kg	1088016

IP 54 BATTERY COVER



IP 54 Battery cover for 12 Ah

All SMART-FORCE battery rescue tools come with an IP 68 battery cover and an IP 54 battery cover for 5.5 Ah and 8 Ah M18™ High Output™ batteries. Using 12 Ah 18 V MILWAUKEE M18™ High-Output battery batteries, the larger IP 54 battery cover (part no. 1101405) can also be purchased.

- to protect the battery from mechanical damage (moisture and splash water)
- tool achieves protection class IP54
- allow a quick battery change in regular operation scenarios

Suitable for all SMART-FORCE devices

	Part-no.
IP 54 battery cover for 12 Ah	1101405

RIT BACKPACK CARRIER



For easy transport of battery-powered devices on the back

- two pockets offer additional space for batteries, tips and other accessories
- optimal weight distribution ensures optimum carrying comfort even over longer distances
- tough and durable material (Cordura nylon with water-repellent coating)

Suitable for:

RIT-Tool E-FORCE/SMART-FORCE	SPS 400 MK2 E-FORCE/SMART-FORCE
RIT-Tool HANDVARIO	SPS 270 H
SPS 270 MK2 E-FORCE/SMART-FORCE	SP 44 AS E-FORCE / SMART-FORCE
SPS 360 MK2 E-FORCE/SMART-FORCE	RSC 170 (PLUS) E-FORCE / SMART-FORCE
SPS 370 MK2 E-FORCE/SMART-FORCE	RSC 190 (PLUS) E-FORCE / SMART-FORCE

	Weight	Part-no.
Bagpack Carrier	2.6 kg	1100364

BATTERY ACCESSORIES 28 V (E-FORCE)



	Weight	Part no.
Spare battery 28 V 5,0 Ah WEBER RESCUE	1.0 kg	1072893
Spare battery 28 V 5,0 Ah von Milwaukee	1.0 kg	1075189
Mains charger 230 V for 1 battery	0.8 kg	1054097
Power supply 110 V for one battery 28 V	0.8 kg	1054099
On-board charger 110 V for 1 battery	1.0 kg	1060423
E-FORCE 28 V Power supply 230 V	4.0 kg	1060422
E-FORCE 28 V Power supply 110 V	5.0 kg	1060426

TRANSPORT BAG CARRYING STRAP AND BATTERY POUCH



	Weight	Part-no.
Transport BAG for battery-powered devices	1,8 kg	1058128

RIT-Tool E-FORCE/SMART-FORCE	RSX 160 E-FORCE
SPS 270 MK2 E-FORCE/SMART-FORCE	RSU 180 E-FORCE
SPS 360 MK2 E-FORCE	SP 44 AS E-FORCE/SMART-FORCE
SPS 370 MK2 E-FORCE	

further transportation systems	Weight	Part no.
Battery pouch for one battery (without belt)	0.2 kg	1056921
Belt for battery pouch	0.1 kg	1056920
Carrying strap	0.3 kg	1078259
Fixation strap	0.1 kg	1078261
Carrying strap set (1 carrying strap + 1 fixation strap)	0.4 kg	1080657

HIGH-OUTPUT BATTERY AND CHARGERS 18 V (SMART-FORCE)



BATTERIES	Weight	Part-No.
M18™ High-Output battery 5,5 Ah	1.1 kg	1101254
M18™ High-Output battery 8,0 Ah	1.1 kg	1099928
M18™ High-Output battery 12,0 Ah	1.7 kg	1099929
CHARGERS	Weight	Part-No.
Charger for 1 battery M12-18 - 230 V	0.7 kg	1101257
Charger for 1 battery M12-18 - 110 V	0.7 kg	1102000
Quick-charger for 1 battery M12-18 - 230 V	1.0 kg	1101265
Double charger for 2 batteries M12-18 - 230 V	1.8 kg	1101263
Multi charger for 6 batteries M18 - 230	1.9 kg	1101264
On-board charger for 1 battery M12-18 - 12-24 V	0.7 kg	1101262
Power supply 230 V/ 110 V 18 V	4.0 kg	1099997

ADDITIONAL BATTERY EQUIPMENT

Practical cordless hand tool and accessories from the Milwaukee M18™ range

- selected cordless hand tool especially for accident rescue and technical assistance
- powerful and flexible to use, ergonomic tools with low weight
- MILWAUKEE REDLITHIUM-ION™ HIGH OUTPUT™ battery technology for the toughest working environments and with intelligent electronics for better power control
- full system compatibility with over 250 MILWAUKEE M18™ product solutions and the new SMART-FORCE rescue tool series
- all devices are supplied without batteries and chargers, these can be ordered individually.

Battery hand tool	Type	Weight	Dimensions	Part-No.
battery angle grinder 125 mm	M18 FSAG125XB-0X	4.6 kg	475 x 358 x 132 mm transport case (HD-box)	1101787
battery angle grinder 230 mm	M18 FLAG230XPDB-0C	10.6 kg	710 x 540 x 185 mm transport case	1101788
battery cut-off saw 230 mm	M18 FC0S230-0	7.0 kg	660 x 340 x 290 mm cardboard	1101791
battery grinder	M18 FDG-0X	4.3 kg	475 x 358 x 132 mm transport case (HD-box)	1102032
battery sprayer with chemical tank	M18 BPFPH-0 + M18 BPFPCST	9.3 kg	620 x 370 x 325 mm cardboard	1104875 1104876
battery towerlight 6000 lumen	M18 HOSALC-0	14.5 kg	1.100 x 320 x 300 mm cardboard	1102033
battery light 300 lumen	M18 IL-0	0.9 kg	320 x 120 x 85 mm blister	1102034
battery spotlight 1250 lumen	M18 SLED-0	1.8 kg	280 x 140 x 120 mm cardboard	1102035

Battery hand tool	Type	Weight	Dimensions	Part-No.
Battery reciprocating saw	M18 FSX-0C	8.6 kg	624 x 467 x 142 mm transport case	1101784
Battery circular saw	M18 FMCS-0X	6.3 kg	475 x 358 x 230 mm transport case (HD-box)	1101785
Battery jigsaw	M18 FBJS-0X	4.8 kg	475 x 358 x 132 mm transport case (HD-box)	1101790
Battery multitool	M18 FMT-0X	4.4 kg	475 x 358 x 132 mm transport case (HD-box)	1102602
Battery chain saw 40 cm	M18 FCHS-0	7.3 kg	890 x 280 x 240 mm cardboard box	1101789
Battery pruning saw 20 cm	M18 FHS20-0	3.2 kg	550 x 270 x 125 mm cardboard box	1104381
Battery percussion drill	M18 FPD2-0X	4.2 kg	475 x 358 x 132 mm transport case (HD-box)	1101786
Battery impact driver 1/4"-hex	M18 FID3-0X	3.4 kg	475 x 358 x 132 mm transport case (HD-box)	1104382
Battery combi hammer drill SDS-PLUS	M18 ONEFHPX-0X	5.7 kg	475 x 358 x 132 mm transport case (HD-box)	1102031
Battery combi hammer drill SDS-MAX	M18 FHM-0C	14.8 kg	670 x 543 x 183 mm transport case	1103755

STEP DRILL

High-quality accessories for drill screwdrivers and hammer drills, suitable for all common applications

	Type	Content	Material	Part-No.
	SHOCKWAVE impact duty bit set	24 standard bits, 5 long bits, 3 sockets & 1 bit holder	all screw types, impact resistant	1097698
	THUNDERWEB metal drill set	19 HSS-G twist drill from 1 - 10 mm	alloyed and unalloyed steel up to 900 N/mm ²	1089460
	RAPID STRIKE step drill	1 step drill, 6 to 35 mm 14 steps, 90 mm length	alloyed and unalloyed steel, aluminum, stainless steel and plastic	1100782
	SDS-PLUS MX4 hammer drill	7 twist drill 5 / 6 x 115 mm, 6 / 8 / 8 / 10 x 165 mm, 12 x 160 mm	concrete and reinforced concrete	1089458
	SDS-PLUS chisel set	1x pointed chisel 250 mm 1x flat chisel 250 mm x 25 mm 1x wide chisel 250 mm x 40 mm	concrete and hard materials	1097697
	SDS-MAX flat chisel	1x flat chisel 280 mm x 25 mm	concrete and hard materials	NEW! 1103759
	SDS-MAX pointed chisel	1x pointed chisel 280 mm	concrete and hard materials	NEW! 1103758
	SDS-MAX hammer drill	1x hammer drill 370 mm x 35 mm	concrete and reinforced concrete	NEW! 1103756
	SDS-MAX hammer drill	1x hammer drill 570 mm x 35 mm	concrete and reinforced concrete	NEW! 1103757
	Adapter set 1/4" HEX	1/4" Hex to 1/4", 3/8" und 1/2" square (DIN 3126)	square impact nuts, impact resistant	NEW! 1104384
	Impact nut set 1/2"	10 long impact nuts: 10 / 11 / 12 / 13 / 14 / 17 / 19 / 21 / 22 / 24 mm	1/2" square	NEW! 1097696

OTHER

High-quality accessories for angle grinders, impact wrenches and matching hand tools

	Type	Spezification	Part. No.
	JABSAW handle for reciprocating saw blades	suitable for all recip saw blades with universal mount foldable up to 150 mm saw blade length ergonomic softgrip handle incl. 150 mm metal reciprocating saw blade	1100783
	Nailing iron	254 mm long tool for removing interior trim and prying open gaps, etc.	1101805
	Tool locking device	Tool safety device with impact damping for working at height and equipment up to 6.8 kg Carabiner with 2-way safety device and swivel.	1101806
	FASTBACK Rescue knife	universal folding knife with one-hand operation tool-less blade change incl. storage patented belt clip and integrated belt cutter replacement blades (5 pcs.) can be ordered with ID 1101804	1101803
	Bolt cutter	Telescopic arms for easy cuts and compact length. Cutting capacity 12 mm (at 19 HRC). Rolled steel blades, pivoting head. Length: 610 to 770 mm	1103504
	Bubble Level Pocket 360°	Magnetic stand (V-groove), 360° adjustable bubble level. Compact size for any pocket. Shows the change of position of lifted loads or structures at risk of collapse	1103240
	PACKOUT First aid kit	First aid kit, certified according to DIN 13157. High quality PACKOUT organiser with IP65 (protection against dust, water and dirt).	NEW! 1101807







SAW BLADE

High-quality saw blades for hand-held circular saw and jigsaw suitable for use

type	content	material	ID
 Metal circular saw blade	1 pc diameter: 174 mm number of teeth: 50 bore: 20 mm	metal (< 2,5 mm)	1059188
 Metal circular saw blade	1 pc diameter: 150 mm number of teeth: 34 bore: 20 mm	Aluminum, mild steel, sandwich material, steel (< 2.5 mm)	1101802
 Multitool saw blade set	5 pcs 1x saw blade 35 mm for wood 2x saw blade 35 mm for wood with nails 2x saw blade 28 mm for metal	Softwood, hardwood, wood with nails, metal, aluminum	1102603
 Multitool hard metal saw blade	1 pc Width: 35 mm Carbide teeth	High strength metal, steel, aluminum, wood, plastic	1102604
 Saw chain	1 pc For 40 cm saw sword Pitch: 3/8" Driving links: 56 Driving link thickness: 1.1 mm	Softwood, hardwood, green wood	1101801
 Jigsaw blades T-receptacle	5 pcs wood saw blade 75x4.0 mm T144D wood saw blade 75x2.5 mm T101B metal saw blade 55x1.2 mm T118A metal saw blade 55x2.0 mm T118B plastic saw blade 75x3.0 mm T111C	wood, plastic and metal	1089459
 Saw chain	1 pc For 20 cm saw sword Pitch: 3/8" Driving links: 40 Driving link thickness: 1.1 mm	Softwood, hardwood, green wood	NEW! 1104383

CUTTING DISCS

High-quality accessories for grinders and cut-off saws

type	content	ID
 PRO+ SCS 41/125 metal cutting disc	disc diameter: 125 mm bore diameter: 22.2 mm (for M14) max. Revolutions: 12200 RPM suitable for: Acid resistant steel, hardox, cast iron, spring steel, mild steel and tool steel	1089457
 STEELHEAD 125 diamond cutting disc	disc diameter: 125 mm bore diameter: 22.2 mm (for M14) max. Revolutions: 15200 RPM suitable for: Stainless steel, steel, heavily reinforced concrete	1103195
 PRO+ SCS 41/230 metal cutting disc	disc diameter: 230 mm bore diameter: 22.2 mm (for M14) max. Revolutions: 6650 RPM suitable for: Acid resistant steel, hardox, cast iron, spring steel, mild steel and tool steel	1101800
NEW!  STEELHEAD 230 diamond cutting disc	disc diameter: 230 mm bore diameter: 22.2 mm (for M14) max. Revolutions: 8300 RPM suitable for: Stainless steel, steel, heavily reinforced concrete	1103196
 Speedcross HUDD diamond cutting disc	disc diameter: 230 mm bore diameter: 22.2 mm (for M14) max. Revolutions: 8300 RPM suitable for: Concrete, stone, brick, screed, granite, gneiss, ...	1101799



BATTERY RECIP SAW SET FSX 18 V



Battery recip Set FSX 18 V

- tactical reciprocating saw set suitable for fire department missions
- useful set assembly in a clearly arranged transport case with inlay
- 18 V heavy-duty battery reciprocating saw from Milwaukee incl. two 5,5 Ah high-output batteries
- additional compartment for saw blades in rolled bag and a safety goggles
- standardized transport case for 60 x 40 cm vehicle mounting dimensions
- transparent lid for direct view into the case, as well as all-round labeling

	Weight	Part no.
Battery recip saw Set FSX	9.8 kg	1102651
MILWAUKEE battery recip saw M18™ FSX, MILWAUKEE high-output battery M18 5,5 Ah 2x, safety goggle according to EN 166, holster for spare saw blades, special recip saw blade set EXTRICATION, standard recip saw blade set DIN (MILWAUKEE), in carrying case incl. foam insert		

BATTERY METAL CIRCULAR SAW 28 V



Powerful cordless metal circular saw for a cold, burr and spark free cut

- QUICKSTOP motor brake (saw blade stops within seconds)
- handle with softgrip support
- spindle lock for easy saw blade change

	Weight	Part no.
MILWAUKEE metal circular saw 28 V Single device HD28 MS-0 without battery, charger and case	3.2 kg	1059178

BATTERY RECIP SAW SET FPD2-OX 18 V



Battery impact drill set FPD2

firefighter-ready set with the MILWAUKEE M18™ cordless impact drill FPD2 in our well-known case system.

	Weight	Part no.
Battery recip saw Set FPD2-18 V	8.7 kg	1102652
MILWAUKEE M18™ FPD2 cordless impact drill, 2x 5.5 Ah 18 V high-output batteries, EN 166 safety glasses, step drill, GLAS-EX TURBO, bit set and metal drill bit set.		

BATTERY RECIP SAW 28 V



Powerful cordless reciprocating saw for universal cutting and sawing work

- safe working thanks to the kickback protection system and safety coupling
- tool-free and quick saw blade changes thanks to quick-change saw blade holder

	Weight	Part no.
MILWAUKEE recip saw 28 V Single device SBS 28-A without battery, charger and case	3.6 kg	1059177
MILWAUKEE recip saw 28 V SET Single device SBS 28-A, 2 batteries 5 Ah, charger 230 V and case	9.0 kg	1078452

BATTERY RECIP SAW SET PREMIUM 28 V



Tactical reciprocating saw set suitable for fire department missions

- useful set assembly in a clearly arranged transport case with inlay
- standardized transport case for 60 x 40 cm vehicle mounting dimensions
- holster for saw and special saw blade sets included
- transparent lid for direct view into the case, as well as all-round labeling

	Weight	Part no.
Battery Recip Saw Set Premium 28 V	8.7 kg	1092557
MILWAUKEE battery recip saw HD28 SX, 2x MILWAUKEE battery M28 5.0 Ah, safety glasses according to EN 166, holster for recip saw, special saw blade set EXTRICATION, special saw blade set VEHICLE RESCUE, transport case incl. foam inlay		

BATTERY ANGLE GRINDER 28 V



Powerful cordless angle grinder with 125 mm disc diameter

- 4-pole motor for highest performance with compact design
- long, slim spindle neck for working in hard to reach place
- spindle lock and Fixtec quick-release nut for quick disc changes without tools
- overload and restart protection

	Weight	Part no.
MILWAUKEE angle grinder 28 V Single device HD28 AG125-0 without battery, charger and case	5.1 kg	1089450
MILWAUKEE angle grinder 28 V SET Single device HD28 AG125-0, 2 batteries 5 Ah, charger 230 V and case	2.8 kg	1089451

RECIP SAW BLADES EXTRICATION



Recip saw blades specially developed for accident rescue

- special saw blades with carbide teeth for high strength vehicle steels
- reinforced blade body against breaks and for less vibration
- Perma-Shield coating for less heat generation
- suitable for almost all common reciprocating saws

	Part no.
Blade EXTRICATION SET including rolled bag 4 pcs. blades 150 mm / carbide tips 6 pcs. blades 230 mm / carbide tips	1078478E
Blade EXTRICATION 150 mm	1078476
Blade EXTRICATION PLUS 230 mm	1078477
Roll up bag for blades EXTRICATION	1081947

FURTERH RECIP SAW BLADES



	content	specification	Part no.
TORCH CARBIDE 150 mm	1 pc	high-strength metal, Stainless steel, cast iron, aluminium	
TORCH CARBIDE 230 mm	1 pc	high-strength metal, Stainless steel, cast iron, aluminium	
TORCH CARBIDE 300 mm	1 pc	high-strength metal, Stainless steel, cast iron, aluminium	
TORCH 150 mm	5 pcs	strong metal, sheet metal, aluminium	
SAWZALL 240 mm	3 pcs	greenwood, thick branches, trees	

SAW BLADES SET VEHICLE RESCUE



Reciprocating saw blades with special carbide teeth for high-strength automotive steels

- reinforced blade body against breakage and for less vibration
- perma-Shield coating for less heat generation and friction

	Part no.
Saw blades VEHICLE RESCUE SET in rolled bag consisting of 4 pieces saw bladesr VR 150 mm 6 Stück saw blades VR 230 mm	1091976
saw blades VEHICLE RESCUE 150 mm	1091974
saw blades VEHICLE RESCUE Plus 230 mm	1091975
rolled bag for saw blades VEHICLE RESCUE	1091977
saw blade TORCH CARBIDE 150 mm	
saw blade TORCH CARBIDE 230 mm	
saw blade TORCH CARBIDE 300 mm	

HOLSTER FOR RECIPROCATING SAW BLADES



Holster for mounting directly on the reciprocating saw

- suitable for most models
- offers space for two reciprocating saw blades (short and long) up to 230 mm
- sewn-in wedge facilitates removal of the saw blades
- worn blades can be replaced in seconds
- integrated magnets keep the holster open
- rubber coating on holster and strap for perfect grip

Dimensions	250 x 50 x 15 mm
Weight (without content)	0.1 kg
Max. length belt	300 mm
Distance front belt	80 mm
Part no.	1083101

BLADE SET ACCORDING TO DIN



DIN saw blades in roller bag

- fulfils the German vehicle standard
- covers all required blades.

	Part-no.
Sabre saw blade SET UNIVERSAL according to DIN in rolled bag consisting of 5 pieces saw blades wood/plastic 230 mm 5 pieces saw blades wood/greenwood 230 mm 5 pieces saw blades wood with nails 150 mm 5 pieces Saw blades for metal 230 mm 5 pieces Saw blades universal 200 mm	1103181
Saw blade wood/plastic 230 mm	1059183
Saw blade wood/greenwood 230 mm	1059184
Saw blade wood with nails 150 mm	1059186
Saw blade for metal 230 mm	1059182
Saw blade universal 200 mm	1059187
Rolled up bag	1103180

CUTTING DISC SET RESCUE

Cutting disc set RESCUE

- set of 3 cutting discs with 230 mm for fire brigade use
- in practical transport bag



	Part. no.
Cut-off wheels SET RESCUE in folding bag consisting of 1x 230 mm standard metal cutting disc 1x 230 mm diamond cutting disc for brick, concrete, stone 1x 230 mm diamond cutting disc for stainless steel and steel	1103427

STANDARD POWER UNITS

- with petrol engines or electric motors
- equipped with a turbo function (TURBO-SPEED), which allows the work to be carried out at even higher speed and with greater dynamics
- a high oil volume (6.5 l) enables the simultaneous operation of all rescue tools in use
- control is implemented illuminated control button
- the double hose reel with ultra-high-pressure hoses and integrated retractor is available in different versions and lengths
- with integrated retractor
- the large peripheral carry handle and the directly integrated device holder make the standard power units user-friendly



scan/click
QR Code!



E 70 W-SAH 20



High-performance electrical power unit

- E-motor 230 Volt, 50 Hz, 2 kW
- high operating speed due to high performance pump
- with twin or COAX hoses, available in different lengths

- TURBO-SPEED
- SINGLE
- COAX

	E 70 W-SAH 20	E 70 W-SAH 20 COAX
Nominal pressure	700 bar	700 bar
Oil volume	6.5 l	6.5 l
Useable volume	6.0 l	6.0 l
EN class	ATO/MTO	ATO/MTO
Weight	74.2 kg	73.0 kg
Part no.	1078718	1069283

V 70 W-SAH 20



High-performance combustion unit with petrol engine

- 4-stroke petrol engine, 4 kW
- high operating speed due to high performance pump
- with twin or COAX hoses, available in different lengths

- TURBO-SPEED
- SINGLE
- COAX

	V 70 W-SAH 20	V 70 W-SAH 20 COAX
Nominal pressure	700 bar	700 bar
Oil volume	6.5 l	6.5 l
Useable volume	6.0 l	6.0 l
EN class	ATO/MTO	ATO/MTO
Weight	75.9 kg	76.5 kg
Part no.	1078719	1058332

TURBO-SHIFTING

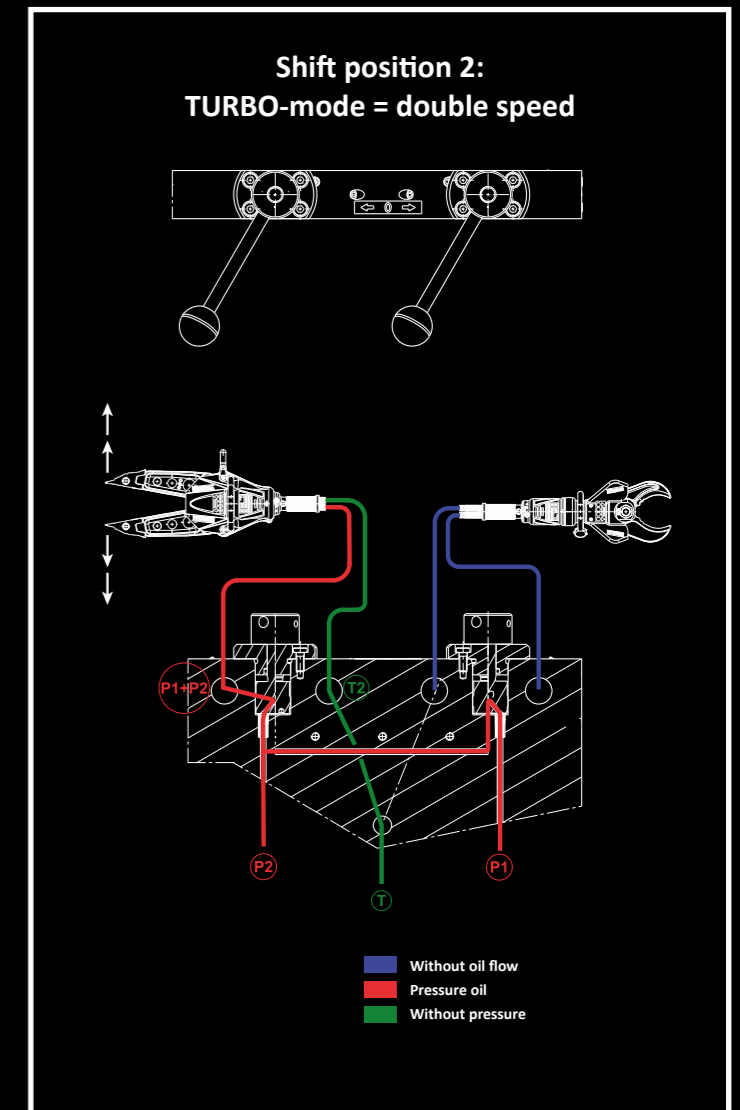
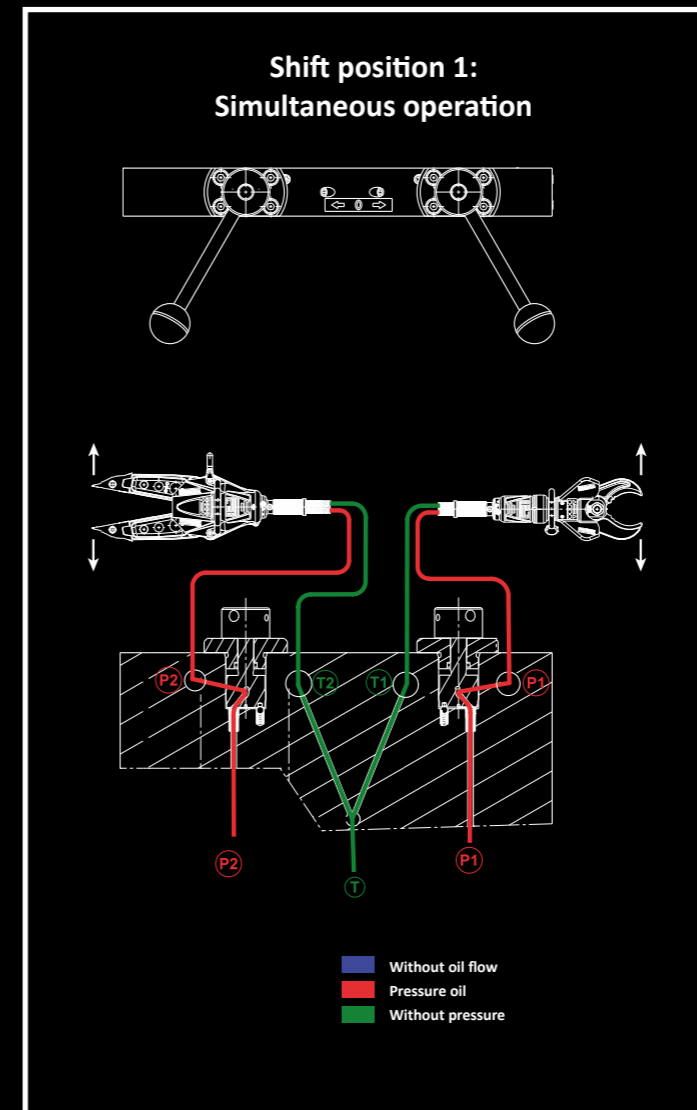

COMPACT AND BATTERY POWER UNITS

- small, lightweight and handy
- maximum power in most confined spaces
- fully functional even on extreme slopes (up to 30 degrees)
- ECO function, which means that automatic speed regulation ensures low-noise and economical operation
- battery-powered units have connection ports for two rechargeable batteries so that they can run for up to 10 hours in ECO mode
- all rescue equipment from WEBER RESCUE SYSTEMS (even large rescue rams) can be operated with these power units

V 400 S/ V 400 ECO



Handy compact power unit with petrol engine

- 4-stroke petrol engine, 1,5 kW
- sturdy carry frame
- high output – quick work
- V 400 ECO with ECO mode for economical operation

	V 400 S	V 400 ECO
Nominal pressure	700 bar	700 bar
Oil volume	2.5 l	2.5 l
Useable volume	2.0 l	2.0 l
EN class	STO	STO
Weight	17.4 kg	17.5 kg
Part no.	5934753	5936853

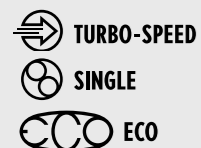

V 50 S/ E 50 S



Pumps with automatic speed regulation for a low-noise and economical operation

- available with petrol engine or electric motor
- can be operated from either side, with turbo function or simultaneous operation of two tools (Turbo-Speed)

	V 50 S	E 50 S
	4-stroke petrol engine	E-Motor 230 V, 50 Hz
Power	3,4 kW	1,3 kW
Nominal pressure	700 bar	700 bar
Oil volume	4.0 l	4.0 l
Useable volume	3.15 l	3.15 l
EN class	ATO/MTO	ATO/MTO
Weight	31.4 kg	33.5 kg
Part no.	5934460	1070365

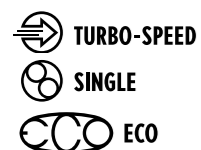

AUTOMATIC SPEED CONTROL



Engine revs are automatically increased when the tool control button is pressed. Returns to idle revs automatically when control button is released. This means less noise and emissions, saves fuel and extends the running time.

Also available in electronic version for battery power units!



V-ECOCOMPACT 3600



Compact power unit with petrol engine

- 4-stroke petrol engine, 2,2 kW
- can be operated from either side, with turbo function or simultaneous operation of two devices (Turbo-Speed)
- very handy due to low weight
- sturdy carry frame

Nominal pressure	700 bar
Oil volume	3.8 l
Useable volume	3.6 l
EN class	ATO/MTO
Weight	23.7 kg
Part no.	1102567

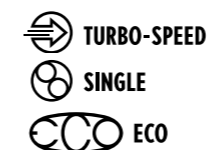

E-COMPACT



Extremely light and handy electric power unit with high performance

- electric motor with 230 V, 50 Hz, 1,5 kW
- extremely light and handy, small dimensions
- very high output
- incl. 4 m electric cable
- designed to operate all WEBER RESCUE equipment!

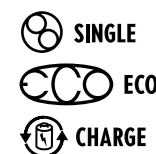

Nominal pressure	700 bar
Oil volume	2.8 l
Useable volume	2.5 l
EN class	STO
Weight	12.2 kg
Part no.	1050354

EXTENSION HOSES



Extension hoses, available as twin or coaxial (hose-in-hose system) hose versions

- ultra-high-pressure hoses, with SINGLE couplings on both ends
- oil-filled, vulcanised as a pair
- COAX hoses prevent the hose becoming twisted



Twin hoses			
Length	Part no. yellow	Part no. red	Weight
5 m	2847647	2847639	4.3 kg
10 m	2847663	2847655	7.5 kg
15 m	2847680	2847671	9.5 kg
20 m	2847701	2847698	13.0 kg

COAX hoses			
Length	Part no. yellow	Part no. red	Weight
5 m	1052602	1052605	3.3 kg
10 m	1052603	1052606	5.5 kg
15 m	1052604	1052607	7.7 kg
20 m	1053457	1053455	10.0 kg

B-COMPACT XL



Compact battery unit with large usable volume for supplying several devices

- up to 10 hours run-time in ECO mode
- small stowage dimension
- ability to connect two 5.0 Ah M28™ Red Li-Ion™
- operation possible by using a power supply 230 V
- designed to operate all WEBER RESCUE equipment
- version V18: incl 2 adapters for M18™ High Output batteries
- batteries not included



	B-Compact XL	B-Compact XL V18
Nominal pressure	700 bar	700 bar
Oil volume	6.1 l	6.1 l
Useable volume	5.1 l	5.1 l
Weight (ready for use)*	15.6 kg	15.6 kg
Part no.	1100371	1100371V18

* Weight incl. battery 5.0 Ah M28™ Red Li-Ion™

FREE STANDING HOSE REELS

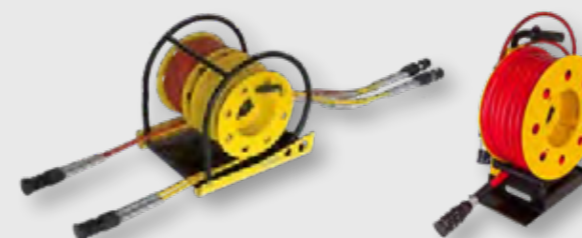

Free standing hose reels with carrying frame and high-pressure hoses (20 m)

- can be operated even when the hose is under pressure
- folding handle(s) for rewinding
- available as single hose reel (EHF) and double hose reel (HF)



HF 20 T	Twin hose	COAX-hose
Weight	36.3 kg	37.6 kg
Part no.	5935016	1054768

EHF 20 T	Twin hose	COAX-hose
Weight	20.5 kg	20.5 kg
Part no. high pressure hose red	5931932	1054236
Part no. yellow	5932491	1054754
Part no. blue	5932661	1055333
Part no. black	5932980	--

AKKUPAC ECO



Extremely lightweight hydraulic power unit with backpack solution

- up to 10 hours running time in ECO mode
- wide and comfortable straps for secure fit
- optional second battery operate two 5.0 Ah M28™ Red Li-Ion™ batteries
- designed to operate all WEBER RESCUE equipment!
- batteries not included

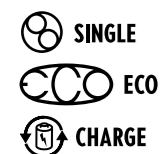

Nominal pressure	700 bar
Oil volume	2.5 l
Useable volume	2.3 l
Weight (ready for use)*	11.2 kg
Part no.	1081828

* Weight incl. battery 5.0 Ah M28™ Red Li-Ion™

HOSE PROTECTION / PROTECTION COVER



For protection against abrasion and contamination

- material: KEVLAR protective coating and duraskin® cover
- velcro fastener
- black hose protection for tools with handle protection sleeve
- protection against pollution and oil penetration under high pressure in the immediate area of the operating personnel
- for 5-20 m hoses
- protection cover available in three different colors

	Hose protection		Protection cover	
Colour	black	red	yellow	blue
Length	30 cm	4 m	4 m	4 m
Part no.	8064563	8051496	8051500	8058024

SPECIALISED TOOLS

Special devices for special applications

- for continuous openings, e.g. at accidents with busses, trains and coaches
- on natural disasters, for creating initial openings in the smallest gaps for lifting bags
- for flexible use in collapsed building scenarios
- for use in industrial incidents
- for quick response in case of disasters, collapsed buildings, breaking doors and to crush thick concrete

C 100-31



Special cutting device for rapid subsequent cut

- specialised tool for continuous cutting, e. g. on busses, trains, coaches, trailers, etc.
- with special space to release the cut material
- several teeth prevent the material from slipping out

Opening	120 mm
EN class	AC120D-19,5
EN cutting class (EN 13204)	1D-2D-3E-4F-5F
NFPA class	A4-B3-C5-D6-E6
Weight	19.5 kg
Part no.	5935199

- SINGLE
- FORGED
- PUSH CONTROL
- 360° HANDLE

CUTTER S 25-20

Compact and versatile cutter

- replaceable carbide inserts for cutting locks, chains, etc.
- suitable for cutting through metal rods and reinforcement
- single-handed use



	S 25-20	S 25-20 E-FORCE
Opening	25 mm	25 mm
Weight (ready to use)	7.6 kg	11.5 kg
Part no.	1070692	1088176

- SINGLE
- FORGED
- PUSH CONTROL
- 360° HANDLE

CONCRETE CRUSHER BC 250



Special device for the most difficult applications

- suitable for quickly breaking thick concrete lumps
- grip and protective guard can be rotated, replaceable tips

- SINGLE
- FORGED
- PUSH CONTROL
- 360° HANDLE

Opening	250 mm
Weight	18.1 kg
Part no.	1063190

POWERWEDGE SPK 250

Wedge-shaped hydraulic spreading device

- creates initial openings in the smallest gaps for lifting cushions
- insertion height only 8 mm
- up to 61 mm lifting height and lifting force 25 t
- EN 13204 and NFPA 1936 tested
- specially hardened spreading plates

- SINGLE
- FORGED
- PUSH CONTROL



	SPK 250	SPK 250 E-FORCE
Weight (ready to use)	9.3 kg	11.5 kg
Part no.	1822861	1088176

MINI-CUTTER C 45-9

Single-action mini cutter

- for cutting tubes, grills, rods, etc.
- very small design
- easiest handling due to low weight and compact shape



Dimensions	267 x 66 x 88 mm
Opening width	45 mm
Round steel bar	18 mm (570 bar) 20 mm (700 bar)
Weight	3.9 kg
Part no.	1070758



BUFFALO B 10



For lifting heavy objects

- can be used vertically or horizontally
- 6-way adjustable lifting claw
- bearing plate for stabilisation

Lifting force	98.0 kN
Total insertion height	800 mm
Piston stroke	350 mm
Weight	38.5 kg
Part no.	198471

Accessories	Part no.
Spherical base	4129881
Square base	4129873
Bearing plate	32255

LIFTING KITS H1 AND H2

Lifting kits available in small (H2) and large version (H1)

- with single-action hydraulic rams and lifting forces up to 137 kN
- including hand pumps and accessories
- DIN 14800
- dimensions aluminium case: 600 x 400 x 220 mm



	Lifting kit 1	Lifting kit 2
Number of cases	2	1
Number of parts	18	13
Weight	77.0 kg	50.8 kg
Part no.	5933552	5933544

HAND PUMP EPH 0203

Ultra-light hand pump

- for use in combination with single-action devices such as DO 105, DO 120 and C 45-9.



Useable oil volume	0.3 l
Delivery per stroke	1.8 cm ³
Nominal pressure	570 bar
Weight	3.3 kg
Part no.	1099835

ACCESSORIES FOR LIFTING KITS MINI-SPREADER SP 1

Mini-Spreader recommended as addition to the lifting kit

- single-acting
- to be operated by hand pump
- for lifting heavy loads, machines, etc.



Lifting force	0.6 kN
Lifting height	87 mm
Weight	2.2 kg
Part no.	358118

HAND PUMP DPH 4018-SA

Manual hand pump used for lifting tools

- two-stage design
- can be used irrespective of position, up to 20° incline
- oil volume 2.5 litres
- with 5 m hose pair and couplings
- mounted on a wooden board
- DIN 14751



Weight	13.5 kg
Part no.	1051174

DOOR OPENER SET DO 105



Door opener set for quick and silent breaking open of doors and lifting of loads

- comprising hand pump, hose, door opener and case
- ultra-light DO 105 door opener with 360° rotating coupling for easy handling
- ultra-light hand pump EPH 0203 with 570 bar nominal pressure
- robust, waterproof case with integrated pressure equalisation valve in Eurobox standard dimensions 600 x 400 x 223 mm incl. insert to protect all equipment
- C 45-9 mini cutter available as optional accessory (compartment already prepared in the case)

Included in the set:	Weight	Part no.
DO 105 door opener	3.3 kg	1099556
Hand pump EPH 0203	3.3 kg	1099835
2 m black hose with SKS quick coupling system	1.2 kg	1099974
Complete set incl. case	11.4 kg	1100718

DOOR OPENER DO 105



For rapid opening doors with complex closing mechanism

- noiseless operation with hand pump
- low weight
- single-action system
- optimized claw for strong hold ini door gap

Closed length	225 mm
Extended length	330 mm
Spreading force	40 kN (570 bar)
Spreading force	49 kN (700 bar)
Weight	3.3 kg
Part no.	1099556

DOOR OPENING SET DO 120



Complete set for rapidly breaking open doors and for lifting concrete slabs, iron beams, etc.

- comprising hand pump, hose, door opener and case
- hydraulic door opener is also available separately

Weight	15.6 kg
Part no.	1075344

DOOR OPENER DO 120



For rapid forcible entry

- noiseless action by using a hand pump
- extra light and handy

Closed length	278 mm
Extended length	398 mm
Spreading force	90.7 kN (570 bar)
Spreading force	114.5 kN (700 bar)
Weight	7.1 kg
Part no.	1075922



DOOR OPENER DO 140 MK2 E-FORCE3



Double-action system specially developed for special applications

- fast and effective breaking open of doors
- metal doors with multiple locks and safety doors also pose no problem
- available as rechargeable battery version (battery not included)

Extended length	105 kN
Piston stroke	140 mm
Weight (ready for use)	13.1kg
Part no.	1101946

ADDITIONAL EQUIPMENT



Useful accessories for rescue operations

- perfect additional equipment to make your rescue operation more easy, more quick and more safe stabilisation
- to stabilise the vehicle simply and precisely
- glass management
- rough edge protective pads, protection shields and patient protection
- airbag protection
- and more accessories

STEP DRILL



Heavy duty step drill for metal from MILWAUKEE

- ideally suited to create starting points for STAB-FAST and tension belts on the accident vehicle
- 14 steps from 6 to 35 millimeters in diameter
- long service life and special geometry for easy work
- suitable for all drill / drivers (10 mm shaft diameter)

Weight	0.18 kg
Part no.	1100782

STAB-FAST ALU +



The universal stabilisation system with new features for even faster and safer work

- automatic rewinding of the tensioning strap
- new improved head for even more stability and hold
- optimised guide piece with integrated lock for more stability
- more flexible length adjustment due to more grid positions
- intuitive operation - all controls in red
- available in three versions

THE NEXT GENERATION OF THE LEADING STABILISATION AND PROTECTION SYSTEM

BASIC EXTRICATION BOX



All important equipment for the first attack in a practical box

- 2 x STAB-PACK
- 1 x GLAS-EX with spring center punch
- 2 x patient protection pad 150 x 200 cm
- 1 x protection shield triangle
- 1 x protection pad 65 x 65 cm
- 1x protection pad 200 x 40 cm
- 1x prying tool
- 1 x rescue scissors
- 1 x marker red
- 1 x adhesive tape WEBER RESCUE
- 1 x tape dispenser
- 1 x bag for gadgets

Dimension (L x B x H)	600 x 400 x 320 mm
Weight	24.5 kg
Part no.	1099879

	STAB-FAST ALU +	STAB-FAST ALU + BASIC	STAB-FAST ALU + XL
	3x standard strut	2x standard strut	2x XL strut
	1x hook knife	1x hook knife	1x hook knife
	1x safety wedge	1x transport bag	1x transport bag
	2x transport bag		
Closed Length	1050 mm	1050 mm	1500 mm
Extended length	1720 mm	1720 mm	2500 mm
Maximum load in longitudinal direction of strut	1750.0/1750.0 kg	1750.0 kg	2500,00 kg
Length of strap	5500 mm	5500 mm	10000 mm
Dimensions	1100 x 300 x 120 mm	1100 x 300 x 120 mm	1600 x 500 x 180 mm
Weight	34.0 kg	19.5 kg	30.5 kg
Part no.	1102643	1102644	1102645

OIL DRIP TRAY



Reusable oil binding mat for collecting leaking operating fluids from vehicles

- For collecting leaking operating fluids in the initial phase
- Easy to place under the vehicle
- Side walls can be turned upwards to form a wall by means of press studs to prevent liquids from flowing out
- Binds up to 5 litres of oil
- Uncomplicated reprocessing with a high-pressure cleaner and detergent after use

Dimension (L x W x H)	900 x 600 x 20 mm
Max. oil absorption capacity	5 l
Weight	0.75 kg
Part no.	1101995

STAB-PACK



System for securely shoring up vehicles

- simple handling - more safety
- can be adapted to different shapes thanks to the two wedges
- safety due to large stand
- permissible load up to 7 kg/cm²
- also available as set (4 pcs. STAB-PACK in Eurobox)

	STAB-PACK	STAB-PACK-SET
Dimension	270 x 187 x 310 mm	600 x 400 x 320 mm
Weight	8.0 kg	35.0 kg
Part no.	8044406	1052771
		Anti-slip mat
Part no.		1102022

STAB-FIX



Elements made of recycled PE for various stabilisation

- recycled PE, durable and shatterproof
- oil- and chemical resistant
- maximum load capacity up to 110 kg/cm²
- no slipping because of pyramid design

Type	Dimension	Weight	Part no.
Chock	640 x 140 x 280 mm	7.3 kg	8066140
Slide Step Chock	620 x 170 x 275 mm	10.0 kg	1067933
Block 25	230 x 230 x 25 mm	1.4 kg	8063818
Block 50	230 x 230 x 50 mm	2.3 kg	8063826
Block 75	230 x 230 x 75 mm	3.4 kg	8063834
Wedge 75	225 x 75 x 80 mm	0.7 kg	3191796
Wedge 150	225 x 150 x 80 mm	1.3 kg	3191800
4 square 100	100 x 100 x 450 mm	3.1 kg	8137242

STAB-LOCK-SET



System for almost all practical stabilisation operations

- waterproof bonded beech plywood
- Lego-block principle
- compatible with STAB-PACK system

Set	Dimension	Weight	Part no.	Pcs. in set
Eurobox	600 x 400 x 320 mm	3.3 kg	1052769	1
Base plate 4 x 6	540 x 360 x 36 mm	4.9 kg	1051857	1
Wedge	230 x 90 x 60 mm	1.5 kg	1051858	4
Top 2 x 3	270 x 185 x 22 mm	1.3 kg	1052594	2
Top 2 x 3 s	270 x 185 x 22 mm	1.1 kg	1051856	2
4 square 2 x 3	270 x 185 x 95 mm	3.0 kg	1051846	1
4 square 2 x 6	540 x 185 x 95 mm	6.4 kg	1051847	1
4 square 1 x 3	270 x 95 x 95 mm	1.5 kg	1051852	1
4 square 1 x 3s	270 x 95 x 95 mm	1.4 kg	1051853	1
4 square 1 x 6	540 x 95 x 95 mm	3.1 kg	1051854	1
4 square 1 x 6s	540 x 95 x 95 mm	3.0 kg	1051855	1
Set no.	600 x 400 x 320 mm	30.5 kg	1052770	

STAB-FIX 4 SQUARE SET



Set made of recycled PE for various stabilisation

- durable and shatterproof
- oil- and chemical resistant
- maximum load capacity up to 110 kg/cm²
- nine PE-pieces in one set
- including transport bag

STAB-FIX 4 square black	9 pieces
Dimension bag	300 x 300 x 450 mm
Weight	28.4 kg
Part no.	8139342

STAB-LOCK XL

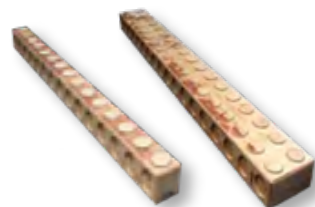

Additional parts for STAB-LOCK system in various Lengths and two widths

- waterproof bonded beech plywood
- Lego-block principle
- compatible with STAB-PACK system

Type	Dimension	Weight	Part no.
4 sq. 1 x 9	810 x 95 x 95 mm	4.4 kg	1052589
4 sq. 2 x 9	810 x 185 x 95 mm	8.6 kg	1051848
4 sq. 1 x 12	1080 x 95 x 95 mm	5.4 kg	1052591
4 sq. 2 x 12	1080 x 185 x 95 mm	11.4 kg	1051849
4 sq. 1 x 15	1350 x 95 x 95 mm	7.4 kg	1052592
4 sq. 2 x 15	1350 x 185 x 95 mm	14.8 kg	1051850
4 sq. 1 x 18	1620 x 95 x 95 mm	9.0 kg	1052593
4 sq. 2 x 18	1620 x 185 x 95 mm	17.2 kg	1051851

STAB-FIX SET BASIC



Flexible STAB-FIX system for stabilisation STAB-FIX in technical rescue

- durable and shatterproof
- oil- and chemical resistant
- maximum load capacity up to 110 kg/cm²
- made of recycled PE
- consisting of 2 chocks, 2 wedges, 2 different blocks
- including transport bag

STAB-FIX Set Basic	
Dimension bag	600 x 400 x 140 mm
Weight	20.5 kg
Part no.	8137676

GLASS MANAGEMENT SET



All important tools for safe glass management with single-pane safety glass (ESG) and laminated glass (VSG) in a single set in a carry case

- Glass-Ex, spring centre punch, lever (also available individually) and rescue cutter
- tape roller with adhesive tape and safety goggles
- 2 x rescue film (also available individually. Change after use)
- in carry case

Dimension case	600 x 400 x 132 mm
Weight	5.6 kg
Part no.	1080917

PROTECTION SHIELDS



Optimum accessories for the protection of the patient

- adjustable hand loops – hands are protected
- two different sizes and shapes – versatile use
- transparent – equipment operator always has a good view of their working area
- flexible – can be bent around posts or pushed into narrow spaces

Overall weight	2.5 kg
Part no.	8136360
Consisting of:	
	Triangle, flexible PVC with 2 yellow grab handles
	Rectangle, flexible PVC with 3 yellow grab handles
Dimension	550 x 350 x 6 mm

GLASS-EX AND CENTRE PUNCH



Set of GLASS-EX plus centre punch

- to remove laminated windscreens (VSG)
- centre punch to remove single-pane safety glass (ESG). Also available individually
- accessory: Replacement blade

	Weight	Part no.
Glass-Ex	1.5 kg	8114161
Centre punch	0.1 kg	8027676
Replacement blade	0.1 kg	8032858

PAT-SAFE PATIENT PROTECTION PAD



Soft blanket to protect the patient from splinters, glass, dust

- ideal size for simultaneous protection of a patient and the rescue worker inside
- made from Cordura 200 with a replaceable Polyglas viewing window
- outer material water-repellent, resistant to tearing and abrasion
- material can be washed at 40° Celsius. Color: Signal yellow
- packaged in transparent carry case

PAT-SAFE	
Dimension	1500 x 2000 mm
Weight	1.5 kg
Part no.	1079078
Replacement window	
Dimension	1000 x 2000 x 0,3 mm
Weight	0.6 kg
Part no.	1079079

GLASS-EX TURBO



For cutting laminated glass panes

- tool for quick removal of LSG (up to 10 mm thickness)
- fits on any cordless drill (10 mm 3-edged socket)
- very agile for cutting tight curves
- most of the glass is conveyed outwards – away from the patient
- due to short blade and the short stroke, cuts directly above the dashboard are also possible

Weight	0.9 kg
Part no.	1095126

PATIENT PROTECTION SET SAFE



Rough edge protection, patient protection blanket and shield within one useful set

- combination of the most important individual products for patient protection
- rough edge protective pad set with ground sheet extended by additional compartments for PAT-SAFE patient protection blanket and rectangle protection
- shieldperfect and high quality protection against sharp edges, splinters, glass dust and flying parts

Dimensions	680 x 460 x 160 mm
Weight	10.5 kg
Part no.	1100647

ROUGH EDGE PROTECTIVE PAD SETS

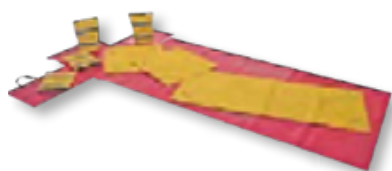

Rough edge protective pad set with ground sheet

- material: CORDURA 200, inner lining Drenotex® polyester fleece
- outer material water-repellent and resistant to abrasion
- inner lining cut-proof
- washable, colour: signal yellow

Dimension	500 x 700 x 95 mm
4 x column protection with 2 hook-and-loop tape	300 x 350 mm
2 x protection blankets, with 4 magnets	650 x 650 mm
1 x protection blanket, with 6 magnets	1650 x 650 mm
Weight	7.8 kg
Part no.	8135517

ROUGH EDGE PROTECTIVE PAD SET UPGRADE



Rough edge protective pad set including WEBER RESCUE clips

- material: CORDURA 200, inner lining Drenotex® polyester fleece
- outer material water-repellent and resistant to abrasion
- inner lining cut-proof
- washable, colour: Signal yellow
- including 8 WEBER RESCUE clips for fixation

Dimension	700 x 500 x 160 mm
2 x column protection with 2 hook-and-loop tape	300 x 400 mm
2 x protection blankets, with 6 magnets	400 x 2000 mm
1 x protection blanket, with 6 magnets	1100 x 2100 mm
Weight	8.6 kg
Part no.	1078945

TRUCK CAGE SAFETY SYSTEM



Secures the truck cab doors against uncontrolled falling

- set includes pressure ratchet, lashing straps and various hooks
- includes standardised transport case

Dimension	600 x 400 x 132 mm
Weight	8.0 kg
Part no.	1083472

OCTOPUS AIRBAG PROTECTION



Protection against unintended triggering of the airbag

- sizes for all cars and trucks
- low weight

Car Driver in transport case	
Dimension	400 x 300 x 132 mm
Weight	1.8 kg
Part no.	1083470
Car Passenger in transport case	
Dimension	400 x 300 x 132 mm
Weight	4.0 kg
Part no.	1083471
Truck	
Weight	0.8 kg
Part no.	8046204

RECOVER-E-BAG

THE INNOVATIVE SYSTEM FOR SECURING AND RECOVERING ELECTRIC VEHICLES

- simple and intuitive one-way quarantine system for electric vehicles after a fire incident
- low water consumption through adaptation to the vehicle contour (all common types of cars)
- suitable for filling with extinguishing water
- mobile and inexpensive alternative to roll-off containers
- roll the vehicle in, lift it or, in tight spaces (underground garages, courtyards, ...), lift it on both sides and undergo the vehicle can be handed over to the tow truck, secured in the system
- contaminated water is retained and can be disposed of properly
- easy to transport and easy to store
- the best solution for fire brigades, towing companies, workshops and car dealerships
- incl. one training bag in the set

Dimensions	5200 x 2300 x 900 mm
Weight total	51.8 kg
Part no.	1100443
Training-BAG	
Part no.	1100699



HALLIGAN-TOOL



Ideal accessories for technical rescue

- available with metal cutting claw or leverage claw
- two lengths available - to enable flexible use
- many possible uses
- non-slip surface on the bar

Halligan-Tool with leverage claw

Length	770 mm	920 mm
Weight	4.5 kg	5.0 kg
Part no.	1089461	1089641

Halligan-Tool metal cutting claw

Length	770 mm	920 mm
Weight	4.5 kg	5.0 kg
Part no.	1089642	1089643

Halligan-Tool with leverage claw black

Length	770 mm	
Weight	4.5 kg	
Part no.	1089461RIT	

STRIKING TOOL (FIRE AXE)

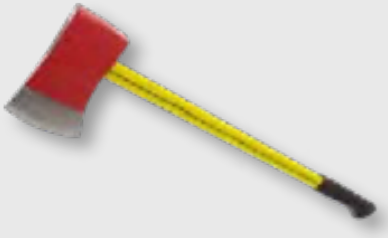

Special striking tool for supplementing the Halligan tool during forced door opening

- can be used both as a wedge for holding open the gap created and for striking in the Halligan tool
- the axe can be struck very deeply into the material thanks to the extremely flat head
- cambered (rounded) impact surface for ideal transfer of force
- sturdy and extra-light fibreglass shaft

Dimension	930 x 220 x 40 mm
Weight	3.8 kg
Part no.	1081980

BREAKING TOOL SET



Combination of striking tool and Halligan tool (length 770 mm)

- velcro strap included in the set for binding and as a carry aid

Dimension	930 x 220 x 160 mm
Weight	8.3 kg
Part no.	1081981

CHAIN RESCUE

Possible areas of application:

- very popular in Scandinavia, especially because of long arriving duration when driving to a place of action
- alternative rescue method without rescue tools in the access area because it is being pulled, not pushed
- if there is not enough time for plan A or B
- a plan + + + (especially for trucks)
- useable in combination with rescue tools
- if a rapid extrication is necessary, as there is mostly enough space in the beginning of the action



CHAIN SET FOR CHAIN RESCUE



Complete chain rescue kit for safe and rapid chain rescue

- the high-performance, quality grade 12 chains are particularly light and have 4-edged chain links that ensure maximum grip when lashing around the vehicle pillars
- the 3 m long chains can be adapted to any length by means of a shortening hook (incl. safety pin)
- designed for use on a 50 kN cable winch
- including weight cover for identifying the steel rope and to protect against whipping around (also available individually)
- packaged in 2 carry cases (for the front and rear of the car)

Dimension case	600 x 400 x 264 mm
Weight	45.5 kg
Part no.	1084562
Also available in aluminium case	
Part no.	1084562ALU

WEIGHT BLANKET FOR STEEL CABLE



For better visibility of tensioned winch cables

- especially at night and in poor weather and visibility conditions
- possible whipping and striking from a tearing steel cable is significantly reduced
- blanket is put in the middle of the cable and fixed by magnets
- made of tear-resistant Cordura, including 2 reflector stripes and an abrasion protector

Dimension	550 x 700 mm
Weight	1.5 kg
Part no.	1084561

RESCUE PLATFORM



For working on hard to reach areas of application

- sturdy aluminium construction, height-adjustable ladder ends
- lockable in 265 mm steps
- height of strut extensions can be independently adjusted in 30 mm steps
- per DIN 14830



Dimension	1050 x 1790 x 280 mm
Platform height (adjustable)	880 - 1700 mm
Max. permissible load	500.0 kg
Weight	51.0 kg
Part no.	1057597

High-Visibility sticker set	
Part no.	1100481

SILL SUPPORT



Ideal addition to rescue rams

- particularly well suited to the most modern vehicles
- prevents the rescue ram from slipping

Weight	12.3 kg
Part no.	1085337

RESCUELIGHT



Rechargeable battery operated lighting for precision illumination of the operation site

- rechargeable battery operated lighting with four powerful LED spotlights
- each spotlight can be individually tilted and angled
- power supply via exchangeable 28 V MILWAUKEE battery (or 18 V MILWAUKEE via additional adapter)
- fold-out, rubberised feet ensure stability
- including a mount for standard tripods and carrier frames

Power	RESCUELIGHT 28V	RESCUELIGHT 28 V+18 V Adapter
Lumious flux	4 x 45 W	4 x 45 W
Dimension	4 x 3.400 Lumen (13.600 Lumen)	4 x 3.400 Lumen (13.600 Lumen)
Weight	430 x 120 x 370 mm	430 x 200 x 370 mm
Part no.	7.0 kg 1084044	7.0 kg 1084044V18

*recommended for 5.0 Ah M28™ Red Li-Ion™ batteries

** recommended for. M18™ High Output batteries

DASHBOARD PRESSING PLATES



Ideal addition to rescue rams

- as a support surface on the centre tunnel and on sills
- prevents the rescue ram slipping

	Weight	Part no.
Base support front	5.6 kg	1824333
Base support back	9.0 kg	1824341

LOAD-PAD



Flexible load distribution element as a optimal supplement for rescue rams and spreaders

- adapts to the ground for the best possible support surface
- load distribution possible even in confined spaces, e.g. in the foot area
- especially for truck rescue flexible and purposeful applicable
- additional replaceable protective mat for sharp-edged application areas



Dimensions L x H x W	420 x 240 x 80 mm
Max. load	200 kN
Weight	7.1 kg
Part no.	1097045

RIM ADAPTER SETS



Ideal as attachment point for the rescue ram for lifting trucks and buses

- in a practical transport case

	Weight	Part no.
Rim adapter set back wheel	19.6 kg	2852144
Rim adapter set back and front wheel	30.7 kg	2854082

SMART RESCUE DUMMY



Very robust training manikin with additional functions for training in accident rescue

- legs and arms can be detached for training purposes
- opening in the chest for impalement injury
- pockets for smartphones on the chest in the head e.g. for communication with the inner rescuer and display of vital parameters via app
- ideal for training and education of rescuing people

NEW!

Dimension (L x W x H)	190 x 50 x 25 cm
Weight	48.0 kg
Part no.	1102653

PATIENT WARMING BLANKET READY-HEAT



For the treatment of uncooling (hypothermia) by active heat supply

- easy activation by opening the packaging and shaking out in the air
- chemical reaction in the 12 heat elements ensures 8 hours of heat retention
- the operating heat of 38-42 °C is already reached after 10-15 minutes
- made of waterproof, coated, non-woven medical fabric with foam core
- trauma equipment for rescue forces, police and military
- hypothermia is a life-threatening drop in core body temperature as a result of shock, burns or ice and avalanche accidents

Dimensions (L x B)	122 x 86 cm
Weight	0.8 kg
Part no.	1084302

ENTRAPMENT SIMULATOR



Entrapment simulator for the realistic simulation of entrapments in vehicles

- inflatable bag made of stable tarpaulin material
- simulation of entrapment of training actors without putting them in direct danger
- M-shaped airbag to be placed in the footwell and trapped at the feet. Release is only possible if space is created in the footwell in advance using hydraulic rescue equipment.
- can be reused as often as required
- filling with a standard air pump

Dimension (L x W x H)	50 x 40 x 40 mm
Weight	1.4 kg
Part no.	1102528

SPINEBOARD AND SHORTBOARD

NEW!

Wooden spineboards for patient rescue from the vehicle

- specially curved and thinner boards made of wood, which make it much easier to get the patient onto the board
- versatile carrying options thanks to side grip holes, also suitable for high-altitude rescue
- suitable for X-ray and CT scan
- floatable and water-repellent
- available as standard version and as shortboard
- accessories for patient fixation optionally available
- made in Spain

Spineboard	
Dimension (L x W x H)	183 x 43 x 1,8 cm
Max. load	220 kg
Weight	5.5 kg
Part no.	1102654

Shortboard	
Dimension (L x W x H)	80 x 43 x 1,2 cm
Max. load	250 kg
Weight	1.8 kg
Part no.	1102655

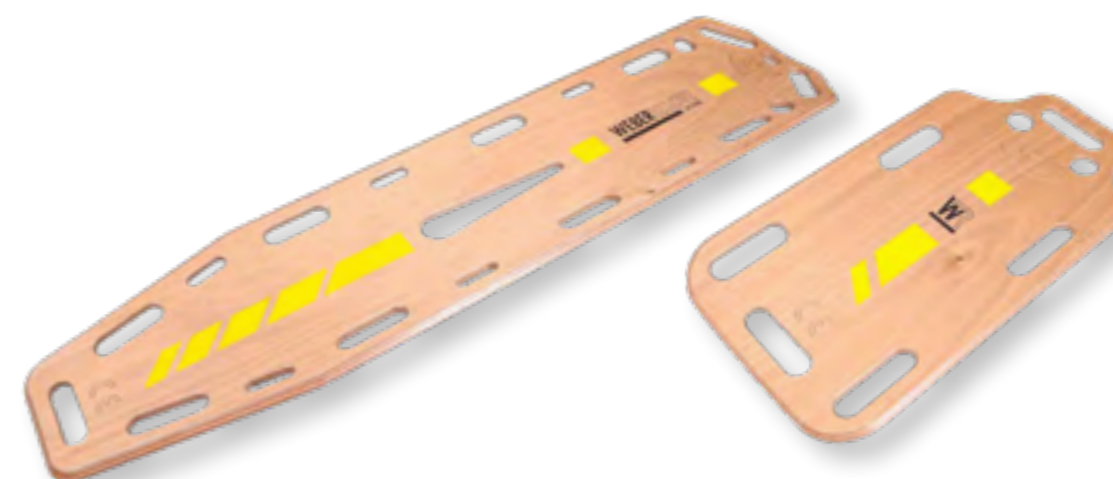

PROTECTIVE GLOVES EXTRICATION 2090W



Protective gloves, developed especially for rescue

- special cut resistant over the complete surface
- impact protection und Nitrile coating
- protection class according EN 388:2016 = 4544XP
- fulfills DGUV
- available in sizes 5–12

You will find additional equipment as
**FASHION • GADGETS • TOOLS • PSA •
EDUCATION • MERCHANDISING**

in our online shop and in our
special fanshop catalogue.

Make your order now online:
www.weber-rescue-shop.com



RESCUE SOFTWARE CRASH RECOVERY SYSTEM

Database containing all mass-production series vehicles. You will find supportive information about:

- airbags and airbag inflators, seatbelt pretensioners and automatic roll bars
- reinforcements, batteries and fuel tanks
- components of alternative propulsion, e.g. high voltage batteries, gas tanks, disabling procedures
- special components of trucks and busses, such as chassis suspension, emergency exits, sleep cabins, lifting points



PROTECTIVE GLOVES EXTRICATION 2090W THERMO



Ideal gloves at low temperatures

- lined glove (fleece) for winter
- special cut resistant over the complete surface
- impact protection and Nitrile coating, in signal colour
- protection class according EN 388:2016 = 4543EP
- fulfills DGUV
- available in sizes 7–11



Mobile, flexible, easy to use

- contains all mass-production series vehicles with airbags or alternative propulsion for cars, vans, light and heavy trucks as well as buses
- consistent, easy to read vehicle graphics
- information on all rescue relevant vehicle components
- extensive background information, photos and disabling instructions
- saves time, increases safety
- disabling instructions allow for a quick mitigation of hazards
- available for Microsoft Windows, Apple iOS (iPAD) and Android
- complete and always up-to-date (regular updates)

PROTECTIVE GLOVES XTREME RESCUE 4011W



Protective gloves, developed especially for rescue

- best materials and characteristics to protect the hands during a rescue scenario
- special SuperFabric cut protection fabric developed for protection gloves
- performance index according to EN 388:2016: 4X43FP (highest cut protection class)
- abrasion-resistant palm with best grip on dry and wet surfaces
- large and stitched rubber impact protection on the outer hand protects against injuries
- Reinforced thumb saddle, tight-fitting neoprene cuff with velcro and grommet
- available in sizes 7–11



Part no.	Content and licence
1052784	Lite Edition for Windows, Apple iOS or Android (1 year license) <ul style="list-style-type: none"> • Databases for Europe, USA, UK and Pacific region • Graphics with all locations of safety components and danger zones • Manual vehicle selection • Monthly online updates for software and database maintenance
1077466	Standard Full Edition for Windows, Apple iOS or Android (1 year license) <ul style="list-style-type: none"> • Databases for Europe, USA, UK and Pacific region • Interactive graphics with single click access to all component information • Digital photos • Deactivation procedures for vehicles with alternative propulsion • Manual vehicle selection using make, model, bodystyle and model year • Monthly online updates for software and database maintenance

LIFTING BAGS 8 BAR

Type	Dimension in mm (L x W x H)	Insertion height in mm	Max. lifting height in mm	Max. lifting capacity in t	Air requirement in l	Weight in kg	Part no.
W 3	230 x 230 x 25	25	130	2.7	15	1.3	8123357
W 10	380 x 380 x 25	25	210	10.1	86	3.5	8123373
W 20	550 x 550 x 25	25	300	21.1	296	7.0	8123390
W 25	610 x 610 x 25	25	340	25.2	416	9.0	8123403
W 41	780 x 780 x 25	25	420	44.6	921	14.0	8123438
W 52	870 x 870 x 25	25	470	55.0	1305	18.0	8123446
W 66	950 x 950 x 25	25	520	70.4	1505	22.5	8123454

LIFTING BAGS 8 BAR FLAT-BAG

	Insertion height in mm	Max. lifting height in mm	Max. lifting capacity in t	Force at max. height in t	Air requirement in l	Weight in kg	Part no.	
W-FB 7/17	550 x 550 x 25	25	170	21.1	6.7	224	7.3	8125740
W-FB 11/17	610 x 610 x 25	25	170	25.2	9.5	350	9.2	8125759
W-FB 18/18	780 x 780 x 25	25	170	44,6	20.2	520	14.5	8125767
W-FB 32/18	920 x 920 x 25	25	170	64,0	33.3	810	20.6	8125775

> GOOD VALUE ECO-PRODUCT LINE



Lifting bags 8 bar Flat-Bag

Lifting bags 8 bar

ACCESSORIES 8 BAR

Type	weight in kg	Part no.
Double controller, fitting	2,0	8123730
Double controller WRP 8/2 NEW!	2,5	1099693
Triple controller WRP 8/3 NEW!	3,6	1099694
Shut-off valve with safety valve	0,4	8125988
Inflation hose 7,5 m blue NEW!	1.1	1104777
Inflation hose 7,5 m red	1.1	1104781
Inflation hose 7,5 m yellow	1.1	1104782
Inflation hose 7,5 m green	1,1	1104783
Inflation hose 15 m blue	2.0	1104784
Inflation hose 15 m red	2.0	1104785
Inflation hose 15 m yellow	2.0	1104786
Inflation hose 15 m green	2.0	1104787

LIFTING BAGS 10 BAR

PHASE OUT

Type	Dimension in mm (L x W x H)	Insertion height in mm	Max. Lifting height in mm	Max. lifting capacity in t	Air requirement in l	Weight in kg	Part no.
W 1-10	150 x 150 x 25	25	80	1.2	7	0.6	1072060
W 7-10	300 x 300 x 25	25	160	6.8	52	2.0	1072062
W 12-10	380 x 380 x 25	25	210	12.1	106	3.5	1057332
W 25-10	550 x 550 x 25	25	300	26.3	362	7.0	1057333
W 30-10	610 x 610 x 25	25	340	31.8	508	9.0	1072065
W 40-10	690 x 690 x 25	25	380	41.3	759	11.0	1072066
W 52-10	780 x 780 x 25	25	420	55.8	1122	14.1	1057334
W 66-10	870 x 870 x 25	25	470	68.7	1595	18.2	1075425
W 85-10	950 x 950 x 25	25	520	88.0	1650	22.7	1075426

LIFTING BAGS 10 BAR FLAT-BAG

PHASE OUT

Type	Dimension in mm (L x W x H)	Insertion height in mm	Max. Lifting height in mm	Max. lifting capacity in t	Force at max. height in t	Air requirement in l	Weight in kg	Part no.
W-FB 2,5/17-10	450 x 450 x 25	25	170	16.6	2.5	220	5.2	1102529
W-FB 8/17-10	550 x 550 x 25	25	170	26.4	8.1	280	7.4	1084841
W-FB 12/17-10	610 x 610 x 25	25	170	31.5	11.9	438	9.2	1084842
W-FB 25/17-10	780 x 780 x 25	25	170	55.8	25.3	650	14.5	1084843
W-FB 42/17-10	920 x 920 x 25	25	170	80.0	41.6	1013	20.5	1084844

STANDARD PRODUCT LINE INCLUDING NEW FLAT-BAG AND FLAT-BAG PLUS LIFTING BAGS



Lifting bags 10 bar Flat-Bag



Lifting bags 10 bar

ACCESSORIES 10 BAR

PHASE OUT

Type	weight in kg	Part no.
Double controller, fitting	2.0	1057331
Double controller WRP 10/2	2.4	1099695
Triple controller WRP 10/3	3.6	1099696
Safety valve with shut-off device	0.4	1078871
Adapter 8 bar accessory for 10 bar air bag	0.2	1078062
Inflation hose 7,5 m blue	1.1	1104788
Inflation hose 7,5 m red	1.1	1104789
Inflation hose 7,5 m yellow	1.1	1104790
Inflation hose 7,5 m green	1.1	1104791
Inflation hose 15 m blue	2.0	1104792
Inflation hose 15 m red	2.0	1104793
Inflation hose 15 m yellow	2.0	1104794
Inflation hose 15 m green	2.0	1104795

LIFTING BAGS 12 BAR

Type	Dimension in mm (L x W x H)	Insertion height in mm	Max. lifting height in mm	Max. lifting capacity in t	Air requirement in l	Weight in kg	Part no.
W 2-12	150 x 150 x 22	22	80	1.4	4	0.5	1100976
W 10-12	320 x 320 x 25	25	170	9.8	63	2.5	1100977
W 17-12	400 x 400 x 25	25	220	16.7	131	4.0	1100978
W 25-12	480 x 480 x 25	25	260	25.1	236	5.7	1100979
W 41-12	610 x 610 x 25	25	340	41.2	681	9.3	1091389
W 50-12	670 x 670 x 25	25	370	50.2	897	11.2	1100980
W 65-12	760 x 760 x 27	27	410	65.2	1010	15.5	1091391
W 80-12	840 x 840 x 27	27	460	80.2	1381	19.0	1100981
W 100-12	930 x 930 x 27	27	510	100.2	1895	23.3	1100982















> HIGH-PERFORMANCE LIFTING BAGS FOR EVEN HIGHER LIFTING CAPACITY

LIFTING BAGS 12 BAR FLAT-BAG **NEW!**

Type	Dimension in mm (L x W x H)	Insertion height in mm	Max. lifting height in mm	Max. lifting capacity in t	Force at max. height in t	Air requirement in l	Weight in kg	Part no.
W-FB 5/17-12	480 x 480 x 25	25	170	24.7	5.0	236	6.6	1104649
W-FB 10/17-12	550 x 550 x 25	25	170	33.2	10.0	365	8.6	1102509
W-FB 20/17-12	670 x 670 x 25	25	170	50.2	20.0	897	12.3	1102510
W-FB 40/17-12	840 x 840 x 27	27	170	80.2	40.0	1381	21.1	1102511
W-FB 55/17-12	930 x 930 x 27	27	170	100.2	55.0	1895	27.5	1102512

ACCESSORIES 12 BAR

Type	weight in kg	Part no.
Double controller, fitting 	2.0	1101381
Double controller WRP 12/2 NEW! 	2.4	1099697
Triple controller WRP 12/3 NEW! 	3.6	1104930
Shut-off valve with safety device (0,3 m hose) 	0.5	1095538
Adapater 8 bar accessories on 12 bar lifting bags NEW! 	0.1	1094717
Inflation hose 7,5 m blue NEW! 	1.1	1104796
Inflation hose 7,5 m red 	1.1	1104797
Inflation hose 7,5 m yellow 	1.1	1104798
Inflation hose 7,5 m green 	1.1	1104799
Inflation hose 15 m blue 	2.0	1104800
Inflation hose 15 m red 	2.0	1104801
Inflation hose 15 m yellow 	2.0	1104802
Inflation hose 15 m green 	2.0	1104803

LIFTING BAG SETS

LIFTING BAG SETS 1 BAR

Type	Consisting of	Weight in kg	Part no.
W 6/1	2x W 6/1, 2x Inflation hose 5 m (yellow/red), Double deadman controller, Universal pressure reducer, Transport bag for two lifting bags	25.5	1819534
W 13/1	2x W 13/1, 2x Inflation hose 5 m (yellow/red), Double deadman controller, Universal pressure reducer, Transport bag for two lifting bags	41.0	1819518

LIFTING BAG SETS 8 BAR NEW!

Type	Consisting of	Weight in kg	Part no.
Light	W 10, W 20, 2x Inflation hose 15 m (red/yellow), Double controller WRP 8/2 Pressure reducer 200/300 bar	18.7	1088482E
Light FLAT	2x W-FB 7/17, 2x Inflation hose 15 m (red/yellow), Double controller WRP 8/2, Pressure reducer 200/300 bar	22.8	1090563E
Light PLUS	W 3, W 10, 2x W-FB 7/17, 2x Inflation hose 15 m (red/yellow), Double controller WRP 8/2, Pressure reducer 200/300 bar	27.6	1088483E
Heavy	2x W 25, 2x W 52, 4x Inflation hose 15 m (red/blue/yellow/green), 2x Double controller WRP 8/2, 2x Pressure reducer 200/300 bar	70.4	1088485E
Heavy Flat	2x W-FB 11/17, 2x W-FB 32/18, 4x Inflation hose 15 m (red/blue/yellow/green), 2x Double controller metal, 2x Pressure reducer 200/300 bar	76.0	1088486E





LIFTING BAG SETS 10 BAR

Type	Consisting of	Weight in kg	Part no.
Light	W 12-10, W 25-10, 2x Inflation hose 15 m (red/yellow), Double controller WRP 10/2, Pressure reducer 200/300 bar	18.7	1101116E
Light FLAT	2x W-FB 8/17-10, 2x Inflation hose 15 m (red/yellow), Double controller WRP 10/2, Pressure reducer 200/300 bar	23.0	31101117E
Light PLUS	W 1-10, W 12-10, 2x W-FB 8/17-10, 2x Inflation hose 15 m (red/yellow), Double controller WRP 10/2, Pressure reducer 200/300 bar	27.1	21101118E

LIFTING BAG SETS 12 BAR NEW!

Type	Consisting of	Weight in kg	Part no.
Light Set	W 10-12, W 25-12, 2x Inflation hose 15 m (red/yellow), Double controller WRP 12/2, Pressure reducer	16.4	1104936
Light Flat Set	2x W-FB 5/17-12, 2x Inflation hose 15 m (red/yellow), Double controller WRP 12/2, Pressure reducer	21.4	1104937
Light Plus Set	W 2-12, W 10-12, 2x W-FB 10/17-12, 2x Inflation hose 15 m (red/yellow), Double controller WRP 12/2, Pressure reducer	25.4	1104939
Heavy Set	2x W25-1, 2x W50-12, 4x Inflation hose 15 m (red/blue/yellow/green), 2x Double controller WRP 12/2, 2x Pressure reducer	50.2	1104940
Heavy Plus Set	2x W-FB 10/17, 2x W-FB 20/17, 4x Inflation hose 15 m (red/blue/yellow/green), 2x Double controller WRP 12/2, 2x Pressure reducer	58.2	1104941

PRESSURE LEVEL-INDEPENDENT ADDITIONAL EQUIPMENT

Type		Weight in kg	Part no.
Compressed air cylinder 6 l, steel, 300 bar (empty)		9.0	8123829
Collection piece 2-fold for compressed air cylinder		1.0	8057990
Universal adapter set		0.3	8058865
Connecting hose 7,5 m green NEW!		0.8	1104805
Pressure reducer 200/300 bar (working pressure 8-15 bar)		1.8	11104933



OIL RESISTANT PIPE SEALING BAGS 2,5 BAR

Type	Dimension unfilled in mm (Ø x Length)	Sealing-Ø in mm	Weight in kg	Part no.
RD-ÖL 40-70	35 x 195	40 - 70	0.3	8131830
RD-ÖL 70-150	68 x 335	70 - 150	0.6	8131848
RD-ÖL 100-200	92 x 535	100 - 200	1.1	8131856
RD-ÖL 150-300	142 x 575	150 - 300	1.9	8131864
RD-ÖL 200-400	192 x 635	200 - 400	3.0	8131872
RD-ÖL 350-600	322 x 865	350 - 600	8.4	8131899
RD-ÖL 500-1000	472 x 1185	500 - 1000	17.3	1101382

OIL RESISTANT WITH BYPASS PIPE SEALING BAGS 2,5 BAR

Type	Dimension unfilled in mm (Ø x Length)	Sealing-Ø in mm	Bypass-Ø in Inch	Weight in kg	Part no.
RDB-ÖL 100-200	92 x 550	100 - 200	1"	2.6	8131929
RDB-ÖL 150-300	142 x 590	150 - 300	1"	4.4	8131937
RDB-ÖL 200-400	192 x 635	200 - 400	2"	6.3	8131945
RDB-ÖL 350-600	322 x 865	350 - 600	2"	16.6	8131961
RDB-ÖL 500-1000	472 x 1185	500 - 1000	2"	31.3	1101383

> OIL RESISTANT VERSION FOR ABSOLUTE SAFETY IN USE



LEAK SEALING BAGS 2,5 BAR

Single bags	Dimension (L x W x H) in mm	Sealing surface in mm	Weight in kg	Part no.
LD 10 x 10	150 x 150 x 12	10 x 10	0.4	1101384
LD 18 x 18	230 x 230 x 12	18 x 18	0.8	1101385
LD 25 x 25	300 x 300 x 12	25 x 25	1.4	1101386
LD 45 x 23	620 x 300 x 20 mit Fixierungsschlitzen	45 x 23	4.5	1101387
LDS 45 x 23	620 x 300 x 20	45 x 23	6.2	1101388

Set	Consisting of	Weight in kg	Part no.
LD 45 x 23	LD 45 x 23, Foot pump, Inflation hose 10 m blue, 4x Lashing strap 10 m yellow, 2x Sealing plate 600 x 300 mm, Acid protection cover	19.2	1101389
LDS 45 x 23	LDS 45 x 23, Foot pump, Inflation hose 10 m blue, 2x Lashing strap 10 m yellow, 2x Lashing strap 2 m yellow, 2x Attachment belt 5 m yellow, 2x Sealing plate 600 x 300 mm, Acid protection cover	21.5	1101390
Mini-LD	LD 10 x 10, LD 18 x 18, LD 25 x 25, Foot pump, 2x Velcro strap 1,5 m, 3x Velcro strap 3 m, Transport case	10.6	1101439



Set LD 45 x 23

Set LDS 45 x 23 with swivel eyelets

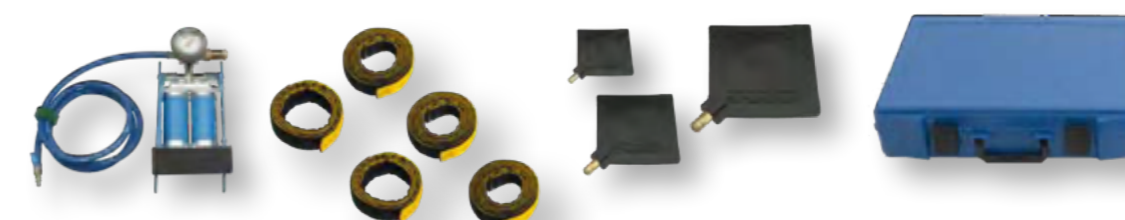

Set Mini-LD

LEAK SEALING LANCES 2,5 BAR

Type	Dimension (L x W x H) in mm	Weight in kg	Part no.
Leak sealing bag wedge 1/6	230 x 60 x 50	0.3	1101392
Leak sealing bag wedge 2/8	230 x 80 x 55	0.4	1101393
Leak sealing bag wedge 3/11	230 x 110 x 70	0.5	1101394
Leak sealing bag cone 4/7	230 x 65 x 65	0.3	1101395
Leak sealing lance 35 cm	350 x 15 x 15	0.3	1101396

Set	Consisting of	Weight in kg	Part no.
Leak sealing lances set	Wedge 1/6, Wedge 2/8, Wedge 3/11, Cone 4/7, 4x Leak sealing lance 35 cm, Foot pump, Shut-off valve, Transport case	8.2	1101391



LEAK SEALING BANDAGES 2,5 BAR

Type	Dimension (L x W x H) in mm	Weight in kg	Part no.
LDB 125 x 250	250 x 125 x 10	2.1	1101397
LDB 210 x 1700	1700 x 210 x 10	6.7	1101398

Set	Consisting of	Weight in kg	Part no.
Leak sealing bandages set	LDB 125 x 250, LDB 210 x 1700, Foot pump, Inflation hose 10 m grey	13.1	1101399



ACCESSORIES FOR SEALING SYSTEMS 2,5 BAR

Type	Weight in kg	Part no.
Pressure reducer 200/300 bar	1.7	8123713
Single controller, fitting	0.9	8123837
Double controller, fitting	4.2	8133786
Double controller, plastic	5.0	8133794
Foot pump with hose 2 m	3.5	8131570
Shut-off valve	0.9	8133816
Inflation hose with deflation plug 5 m, grey	0.9	8133808
Inflation hose with deflation plug 10 m, grey	1.3	8056188
Lashing strap with ratchet 2 m	1.7	8123993
Lashing strap with ratchet 10 m	2.1	8123942
Attachment belt 5 m	0.8	8124019
Velcro strap 1,5 m	0.2	8123926
Velcro strap 3 m	0.1	8123934
Sealing plate 600 x 300 x 30 mm	0.8	8123969
Acid protection cover for LD 45 x 23	0.4	8131694
Acid protection cover for LDS 45 x 23	0.6	8131708



GULLY SEALING BAGS

Type	Dimension (L x W x H) in mm	Weight in kg	Part no.
300-500 0,5 bar	385 x 275 x 275	3.8	8131627
100-150 2,5 bar	200 x 86 x 86	0.6	1101400

Set	Consisting of	Weight in kg	Part no.
300-500 0,5 bar	300-500 0,5 bar, Hose 2 m and Leash, Transport case 610 x 410 x 140 mm	11.2	1819496
100-150 2,5 bar	4x 100-150 2,5 bar, Foot pump, Positioning rod, Transport case 610 x 410 x 140 mm	11.0	1101401

Accessories	Weight in kg	Part no.
Filling valve 0,5 bar 	2.5	8131619
Compressed air cylinder 1 l, 200 bar 	3.0	8123810



COLLECTING TANK

Type	Volume in l	Bottom-Ø in mm	High in mm	Weight in kg	Part no.
AB 2000	2000	2000	800	28.5	8134022
AB 5000	5000	2700	1200	51.9	8124035

Accessories	Weight in kg	Part no.
Hand air-pump	2.3	1094982

Self-supporting folding container

- For collecting hazardous liquids or for water supply with fire-fighting water, artificial snow machines, etc.
- Self-supporting design
- Robust, evenly weighted and can be folded up small compact size
- Easy to maintain
- PES (polyester) fabric with NBR/PVC coating for UV light, ozone and strong weather resistance
- Including coupling system and inflation hose



TABLE OF RESISTANCE



Chemical	Concentration (%)	Temperature (°C)	Lifting bags 1 bar	Lifting bags 8-12 bar Leak sealing bags	Pipe sealing bags	
Acetone		23	2	1	2	
Acetylene			2	1	2	
Ammonium Hydroxide	10 konz.	23	1	1	1	
		23	1	1	1	
Aniline		23	3	2	3	
		100	4	4	4	
Benzene		23	4	4	4	
Boric Acid	10	100	1	1	1	
Brake fluid		50	1	1	1	
		50	1	1	1	
Butanol		100	3	4	3	
Butyric Acid			2		2	
Calcium Hydroxide		100	1	1	1	
Calcium Hypochloride	15		2	4	2	
Chlorid Acid	20	23	4		4	
Ethanol		50	1	1	1	
Ether		23	4	4	4	
Formaldehyde	40	23	1	1	1	
		70				
Glycerol		100	1	1	1	
Hexanol		23	2	1	2	
Hydrogen Peroxide	30	23	1	1	1	
		90		4		
Kerosene		70	3	4	3	
Methanol		50	1	1	1	
Methyl Chlorid			4	4	4	
Milk		23	1	1	1	
Mineral oil Nr. 1		100	1	4	1	
Mineral oil Nr. 2		100	2	4	2	
Mineral oil Nr. 3		100	4	4	4	
Naphtha		23	4	4	4	
Natural gas			1	3	1	
Nitric Acid Diluted	10	50	3	2	3	
Ozone		40	2	4	2	
Phenol		100	4	4	4	
Phosphoric Acid	60	50	2	2	2	
Propanol		50	1	1	1	
Sodium Hydroxide	10	100	1	1	1	
		25	100	1	1	1
Sodium Hypochloride	10	50	3	2	3	
Sulfur Hexafluorid			1		1	
Sulfuric Acid	10	100	1	1	1	
		20	23	1	1	1
		25	100	1	1	1
		50	100	1	1	1
		60	100	4	3	4
		75	23	4	4	4
Toulene		96	4	4	4	
		23	4	4	4	

TRAINING, SEMINARS AND COURSES

Hydraulic rescue tools are versatile tools for the daily use under toughest conditions. To maintain and use our tools correctly it is essential to be trained properly. Therefore we offer not only a wide range of seminars for technical rescue but also courses to learn how to test and maintain our tools correctly.

Seminars for technical rescue

- Extrication of injured persons
- Modern vehicle technologies
- Chain rescue operations

Courses for testing and maintenance

Contact: www.weber-rescue.com/en/kontakt/



RESCUE DAYS TRAINING EVENT

The international rescueDAYS are the world's largest training event for technical rescue operations and have been taking place once a year for more than 15 years at different venues in Germany. WEBER RESCUE also organises smaller rescueDAYS events around the world. Among others, in Japan, Brazil, Ukraine, Poland, Austria, Slovenia and Portugal.

New vehicle technologies and the numerous types of vehicles on our roads always presents new challenges for the fire services and rescue teams. In order to be prepared in these situations, it is necessary to be trained for different incidents and scenarios and to gain knowledge about the technology being used. The training courses covers the areas of car, truck and bus rescue.

During rescueDAYS, participants can learn new rescue techniques and exchange ideas with their colleagues from all over the world, because technical rescue does not work the same way everywhere. Our international instructorTEAM will train approx. 800 participants from all over the world on the four days of the event.



rescuedAYS

For further information please visit: www.weber-rescue.com/rescue-days



scan/click QR Code!

The individual alerting system for aid organisations

- Alerting via push, SMS, call or e-mail
- Overview of available emergency forces
- Alarm monitor
- Readiness queries
- Chat function
- Calendar function
- Shift management
- Thunderstorm module



Test it now for free!
Info at www.retteralarm.com



RETTERAlarm
BY WEBER RESCUE SYSTEMS



Scan QR Code

RETTERALARM ZEUS

The central operation support system for document management and operation documentation as an optimal supplement to RETTERAlarm

- Extension to RETTERAlarm
- Provides even more efficient, comprehensive and detailed mission management
- Display of situation maps and deployment plans
- Operation documentation, which can be used afterwards for the operation report
- Overview of alerted resources and vehicles
- The perfect support for every operation



RETTERAlarm ZEUS

BY WEBER RESCUE SYSTEMS



DIGITAL SUPPORT FOR COMMAND AND CONTROL OF OPERATIONS.

RETTERALARM

ALERT! GO! These words are well known to members of public authorities or organisations who are entrusted with security and emergency tasks. Whether it is the fire department, emergency rescue services, the Federal Agency for Technical Relief or other emergency services: these days, a comprehensive alert system is still not available everywhere, as many emergency services workers still don't have a pager.

RETTERAlarm allows emergency services personnel to be alerted individually, in groups or on a subsequent basis. Users can be alerted by push notification, email, SMS or phone call. It goes without saying these can be chosen individually for each emergency service worker. With RETTERAlarm, you'll never miss an alert again!



THE RIGHT PACKAGE FOR EVERY APPLICATION.
INDIVIDUAL AND FLEXIBLE.

10" TOUCH ALARMDISPLAY

Reliable acquisition of seismographic data on vibrations and movements on mobile devices

- Ideal as digital support for all emergency and training services of aid organisations
- Provides important data on how to handle the patient when rescuing people from buildings or accident vehicles
- Data can be analysed for training purposes
- Detection of vibrations and movements
- Early acoustic warning in case of situation changes
- Training and operation mode
- Different modes with appropriate vibration sensitivity, adjusted to the to the respective type of operation
- Continuous development and updates with new functions



RETTER ACADEMY

Customisable e-learning platform as a supplement to the topics of training and exercise service

- quick and easy to configure
- can be personalised with your own logo and individual colours
- create your own e-learning courses with just a few clicks
- simple administration and provision of content
- with knowledge quizzes, the individual learning success can be monitored independently
- automated certificate creation after completion of a course
- course is possible
- available as app and web application
- personal support



RETTER Academy

BY WEBER RESCUE SYSTEMS

> THE CUSTOMISABLE E-LEARNING PLATFORM FOR AID ORGANISATIONS.

RETTER SEISMO

Reliable acquisition of seismographic data on vibrations and movements on mobile tools

- ideal as digital support for all emergency and training services of aid organisations
- provides important data on how to handle the patient when rescuing people from buildings or accident vehicles
- data can be analysed for training purposes
- detection of vibrations, vibrations and movements
- early acoustic warning in case of situation changes
- training and operation mode
- different modes with appropriate vibration sensitivity, adjusted to the to the respective type of operation
- continuous development and updates with new functions



RETTER Seismo

BY WEBER RESCUE SYSTEMS

> APP FOR THE MEASUREMENT OF SEISMOGRAPHIC DATA TO SUPPORT TRAINING FOR AID ORGANISATIONS.

RETTER AR

Virtual training for emergency services

- safe practice of various emergency scenarios via augmented reality
- frontal car collision, rear-end collision or building fire
- retrieval of technical data on the rescue equipment used in each case

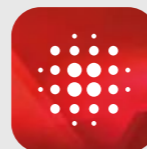

RETTER AR

BY WEBER RESCUE SYSTEMS

> SAFE PRACTICE OF OPERATIONAL SCENARIOS.

WEBER RESCUE ACADEMY

E-learning platform as a supplement to the topics of training and exercise service

- wide range of subject-specific online courses
- perfect supplement to our seminars in the field of technical assistance and accident rescue and accident rescue as well as to our courses on testing and maintenance of rescue equipment
- digital rescueDAYS
- personalised certificates of completion as confirmation of participation
- expert videos from WEBER RESCUE staff and members of our instructorTEAM
- available as app and web application



WR Academy

BY WEBER RESCUE SYSTEMS

> CERTIFICATE COURSES AND SEMINARS FROM OUR TRAINING PROGRAMME.

CRASH SYSTEM

The new Crash System is an easy-to-operate system for safe and accident-free deformation without endangering the emergency forces themselves. The system can be used to simulate all types of accidents, such as front, side, roof or rear accidents, from cars to vans to truck cabins.

This finally enables practical training based on accident scenarios that happen on the roads every day. It is also ideal for demonstrations and public relations training.

- No construction machines or mobile cranes need to be organised or used for other purposes for the deformation of vehicles.
- The system can be set up and operated with minimal manpower (two people).
- It can be loaded by a crane, a winch or a forklift and is ready for use in a maximum of 30 minutes!
- The simulation results are achieved by four cylinders with different punches. By adjusting the pressure, different degrees of destruction can be simulated.
- A static fixation of the vehicles in the guide cage prevents the vehicle from slipping.
- A distance box makes it possible to deform vehicles of different lengths. Thus, even larger vehicles such as vans and SUVs or truck cabs can be deformed with the crash system.
- The system is mounted on a roll-off sub-frame so that it can be pulled up or transported with a swap-body vehicle.

> REALISTIC VEHICLE DEFORMATION FOR PRACTICAL TRAINING IN TECHNICAL ASSISTANCE.

"UNTIL NOW, IT WAS NOT POSSIBLE TO SIMULATE REALISTIC DEFORMATION ON VEHICLES AS IT OCCURS ON CRASH VEHICLES. THE CRASH SYSTEM FROM WEBER RESCUE SYSTEMS IS A REAL WORLD FIRST AND REVOLUTIONIZES THE POSSIBILITIES OF PRACTICAL TRAINING FOR TECHNICAL RESCUE."

Albert Kreutmeyr
Professional firefighter Augsburg, instructor THVU
and co-inventor of the Crash System



Scan QR Code





Tel: 1300 922 303

info@interfire.com.au

WESTERN AUSTRALIA

Unit 1, 23 Christable Way
Landsdale 6065, Western Australia

SOUTH AUSTRALIA

Unit 9 / 28 Heath St
Lonsdale, South Australia, 5160

www.interfire.com.au

WEBERRESCUE
SYSTEMS